

**PERFORMANCE
STARTS IN
YOUR HEAD**

2025 COLLECTION



 **RUDY**
PROJECT

performance starts in your head

Rudy Project believes that true performance begins not on the track, field, or road, but inside an athlete's head. This profound understanding that the mind—where determination, strategy, and vision for success are born—is the cornerstone of our mission. We dedicate ourselves to advancing technologies and designs that not only safeguard the athlete but also enhance focus, perception, and performance.

Our approach combines rigorous scientific research with a commitment to sustainability. Through continuous innovation, using the latest discoveries in materials and aerodynamics, Rudy Project develops sports gear that prioritizes safety, comfort, and performance. Our commitment to environmental and social responsibility ensures our products respect and protect the community and the planet.

ride to zero



At the heart of Rudy Project lies our advanced sports equipment, meticulously designed to optimize athletic performance while adhering to our sustainability ethos. Our products are not just tools for competition; they are instruments that enhance athletic endeavor across various sports, from cycling to running and beyond. The 'Ride to Zero' initiative represents our dedication to reducing our environmental impact. This program aims to significantly lower carbon emissions through sustainable practices in production, the use of eco-friendly materials, and promoting circular economy principles, thereby preserving our global playground for future generations.



ANTONIO TIBERI | TEAM BAHRAIN VICTORIOUS



collection

what's new

- 12 RIDE TO ZERO
- 16 Eyewear Lens Family
- 18 ImpactX® technology
- 20 ImpactX® collection lenses
- 22 Polar 3FX HDR
- 24 RP OPTICS technology
- 26 RP OPTICS collection lenses
- 28 Technology Features

performance

- 32 Kelion
- 34 Cutline
- 36 Defender
- 38 **Turbulence**
- 40 Magnus
- 42 **Nyad**
- 44 Stardash
- 46 Rydon
- 48 Rydon Slim
- 50 Spinshield
- 51 Spinshield Air
- 52 Astral
- 54 **Astral X**
- 56 Sirius
- 58 Deltabeat
- 60 Propulse
- 62 Agent Q

active lifestyle

- 66 Lightflow A
- 67 Lightflow B
- 68 Stellar
- 69 Overlap
- 70 Spinair 57
- 72 **Glamshady**
- 73 **Spinhawk Edge**
- 74 Skytrail
- 75 Soundrise

rx optical

- 78 RX Solutions
- 79 Quick Optical Guide
- 80 ImpactRX Lens Collection
- 82 RP Optics
- 83 Polar 3FX 1.59
- 84 Lens marking
- 86 RX collection
- 90 OPTICAL INSERTS
- 92 OPTICAL DOCK
- 94 RX DIRECT CLIPS
- 96 Inkas / Inkas XL
- 98 RX READERS
- 101 RX FLIP UP
- 102 Inkas /Inkas XL Flip-Up
- 104 RX OPHTHALMIC
- 106 Lightflow A
- 107 Lightflow B
- 108 PULSE 53
- 109 PULSE 54
- 110 Iridis 65
- 111 Iridis 66
- 112 **Stellar | RX**
- 113 **Glamshady | RX**

bike helmets

- 116 Helmets technology
- 118 Aero helmets technology
- 120 Wind Tunnel Testing
- 122 Total safety technology
- 123 RP Rotational Impact Test
- 124 **Wingdream**
- 126 The Wing
- 128 Nytron
- 130 Nytron PRO
- 132 **Rebel**
- 134 Egos
- 136 Spectrum
- 138 Protera +
- 140 Venger Cross
- 142 Venger
- 144 Crossway
- 146 Skudo
- 148 Strym Z
- 150 Helmets Sizing/Fitting

snow

- 154 Spincut
- 156 Skermo

gear & pop

- 160 Cyclingwear
- 160 Socks & Gloves
- 161 Crew & T-Shirt
- 161 Bags & Packs / Helmet Protector
- 162 Displays
- 164 Merchandising
- 166 P.O.P.

style finder

- 168 Eyewear
- 170 Helmets

items in **BOLD** are new entries for 2025



2024 official team supplier

CYCLING



MOUNTAIN BIKE



TRIATHLON



RUNNING



OTHERS



All athletes and/or teams (names and/or pictures) shown in this catalogue are referred only and exclusively to the year 2024.



road

TEAM BAHRAIN VICTORIOUS
© CHARLY LOPEZ



mtb

TEAM METALLURGICA VENETA
© F.CANTONI



x-country

JOHANNES HØSFLØT KLÆBO
© NORDIC FOCUS



extreme



triathlon



gravel

MATEJ MOHORIC
@SPRINTCYCLINGAGENCY



winter

ENRICO MOSETTI
@ELISA BESSEGA



trail running

YOHANN STUCK
© RACEPHOTOS

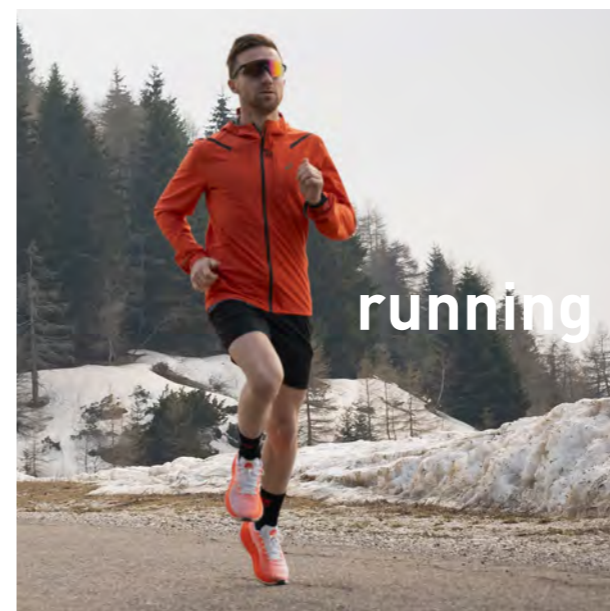

running



outdoor

performance starts in your head

turbulence

This eyewear excels in technology and ergonomics, featuring a unique sweat-bar system for distraction-free performance and shock absorption. The adjustable integrated cord ensures a secure fit, ideal for intense sports. Polar 3FX Multilaser Blue lenses offer clarity and glare reduction, while the customizable nosepiece enhances comfort. Crafted from sustainable Rilsan Clear®, Turbulence combines innovation with environmental commitment.



nyad

Engineered for adventurers and water sports enthusiasts, the Nyad features advanced lens technology such as RP Optics Hi-Altitude and ImpactX Photochromic 2 for clarity in varying light conditions. It includes polarized lenses for optimal glare reduction and multiple color options for style and visibility. Designed with top-tier performance in mind, the Nyad has detachable side shields and offers options for vision correction, making it ideal for any sport or challenge.



astral X

The new ASTRAL X stands out with its wider lenses, ensuring optimal vision without compromising on lightness and sustainability. Eco-friendly materials and vivid colors make ASTRAL X the ideal choice for active and conscious athletes.



glamshady

Discover the "Glamshady" from Rudy Project's 2025 Active Lifestyle Collection, merging style with functionality for everyday wear and light sports. Sleek frames in unique colors like the new Crystal Butterscotch Gloss enhance your dynamic lifestyle.



spinhawk edge

Introducing the Spinhawk Edge by Rudy Project, the perfect blend of style and functionality for the active lifestyle. This evolution of the classic Spinhawk combines sleek design with lightweight durability, ideal for everyday adventures.



what's new



wingdream

2025 Rudy Project Rebel: Innovative and sustainable, This revolutionary "aero-helmet" sets new benchmarks in cycling aerodynamics. Developed with the Bahrain Victorious Team, the Wingdream underwent extensive real-world and wind tunnel testing, achieving a 16.6W improvement in air penetration at 45 km/h over a classic cycling helmet, and surpassing The Wing by 13.9W. It combines rigorous safety standards with comfort features like the RSR 11S Retention System and Fidlock® magnetic closure, making it an indispensable ally for competitive cyclists aiming to dominate against the clock.



rebel

2025 Rudy Project Rebel: Innovative and sustainable, this sports helmet delivers superior performance with recycled materials. Featuring 22 ventilation holes and carbon inserts, it's lightweight and sturdy. Includes comfortable straps with Fidlock magnetic closure and RSR11S retention system for a secure fit.



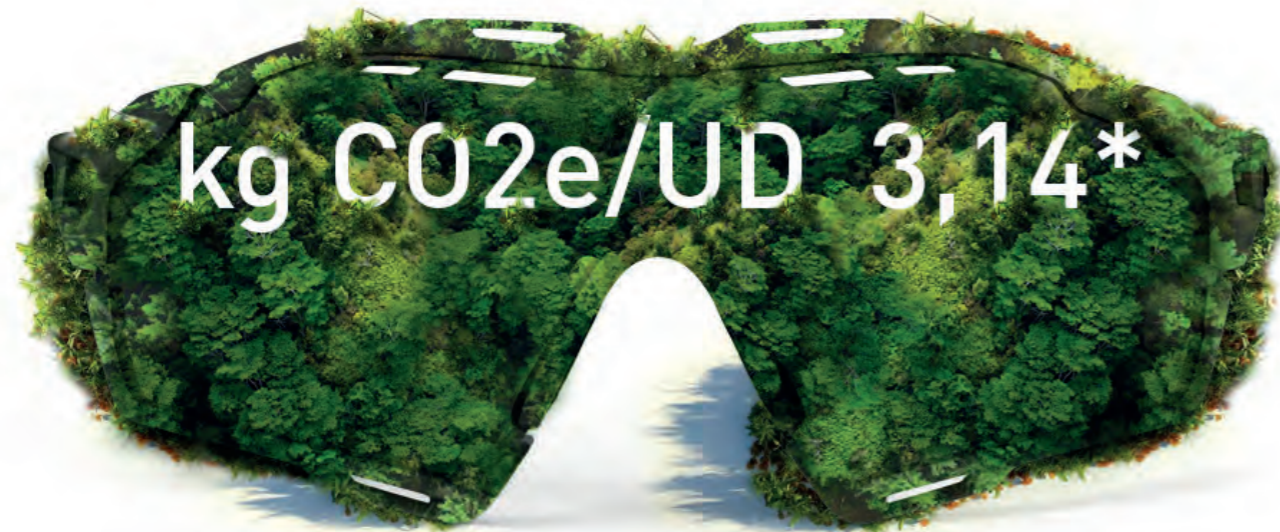

responsible sport eyewear

*REFERS TO CARBON FOOTPRINT CERTIFICATION AGAINST THE YEAR 2020 AND THE CUTLINE MODEL WITH IMPACTX 2 LASER PURPLE LENS.

R&D for reduced Environmental Footprints

Drawing from Rudy Project's years of experience in research and development for product improvement, we are now focusing on using that knowledge to lower the emissions of our products, making a strong effort towards better environmental sustainability.



RILSAN CLEAR is available only on Kelion, Sirius, Astral, Stellar, Magnus, Deltabeat, Overlap, Lightflow, Pulse, Stardash.



RESPONSIBLE FRAME MATERIALS

In our pursuit of "Frame Materials" innovation, we are expanding the use of Rilsan Clear, a bio-plastic derived from 45% castor oil grown by certified farmers in Gujarat, India, who adopt improved farm waste management practices. This environmentally conscious material enables us to reduce our reliance on fossil-based materials for eyewear frames, aligning with our commitment to sustainable and responsible manufacturing. Rilsan Clear is available on a selection of Rudy Project frames; please consult the product information sheets for further details.



MAXIMUM DURABILITY

Rudy Project's exceptional durability sets them apart as a sustainable choice; their long-lasting performance ensures a sound investment in the future, reducing the need to purchase additional eyewear and conserving energy in production. Designed to withstand the most extreme weather conditions, these glasses truly embody the ultimate in lasting quality and eco-conscious design.



TIMELESS DESIGN

Rudy Project's "timeless design" encapsulates an enduring appeal, as their eyewear effortlessly melds Italian style with sporty functionality, resulting in a fashionable yet elegant aesthetic. This evergreen approach ensures that Rudy Project glasses remain perpetually in vogue, transcending fleeting trends while retaining their sophisticated charm.



VERSATILITY

Rudy Project's "versatility" lies in the elegant design of their eyewear, making them ideal for a wide range of sports disciplines, as well as for commuting or strolling through the city. This adaptability ensures both style and functionality, offering a seamless blend of performance and sophistication suitable for diverse activities and environments.



LOW-IMPACT PACKAGING SOLUTIONS

Embracing "Eco Packaging," we have streamlined our approach to minimize waste and unnecessary materials. By eliminating plastic laminations from our paper products, utilizing recycled plastic for our eyewear cases, and eradicating single-use plastic, we are dedicated to fostering a more environmentally responsible packaging solution.



LONG TERM PRODUCT ASSISTANCE

We offer extended support (as a paid service beyond warranty terms) to extend the life of eyewear by replacing scratched lenses or worn-out components. This commitment ensures our customers can maintain and enjoy their Rudy Project glasses for years to come, promoting both sustainability and customer satisfaction.



Rudy Project promotes good health and well-being by offering high-quality sports eyewear and helmets, designed to support outdoor activities and encourage active lifestyles. By enhancing the safety and performance of athletes, we aim to foster better mental and physical health. We are dedicated to promoting sports among young people and supporting inclusive sports activities.



We support quality education through initiatives such as sponsoring the National Interscholastic Cycling Association (NICA), developing mountain biking programs, and organizing Bike Academies. Our involvement in the Ride to Zero program emphasizes cycling safety and sustainability, empowering the next generation of cyclists with the knowledge and skills to ride safely and responsibly.



We support gender equality through initiatives such as the Ride to Equality program, which aims to promote cycling among women in disadvantaged regions of the world, where they might not otherwise have access to professional sports. Within our organization, we ensure equal pay and maintain a balanced gender ratio, promoting fairness and empowerment in sports.



As members of local sustainability groups, we actively promote best practices related to sustainability among companies in our region. Through these collaborations, we foster a culture of shared learning and growth on sustainability issues. Additionally, we organize Bike Academies to enhance urban mobility and encourage sustainable transportation within our community. This collective approach helps build more sustainable and resilient cities.



Some of our durable sunglasses are made from high-quality, bio-based materials. We focus on making our products easy to recycle and use recyclable packaging to reduce waste. Additionally, we continuously research new materials, construction methods, and end-of-life disposal techniques to reduce our emissions. Rudy Project is committed to minimizing our environmental impact through responsible consumption and production practices.



We support climate action through various initiatives aimed at reducing our environmental impact. Our efforts include promoting sustainable practices, reducing carbon emissions, and raising awareness about climate change. These actions underscore our commitment to mitigating climate change and promoting environmental sustainability.



We promote clean energy by installing solar panels on our office rooftops, significantly reducing our environmental footprint and contributing to a greener future. This initiative reflects our commitment to sustainable practices and renewable energy sources.



We foster a transparent workplace by offering comprehensive training programs and supporting local economies through our manufacturing operations in Italy. We promote work-life balance with flexible hours, ensuring our employees can thrive both professionally and personally. Rudy Project is committed to sustainable economic growth and creating a positive impact on our community and beyond.



We invest in sustainable product innovation, prioritize hiring local talent to reduce travel emissions, and actively promote alternative transportation methods. Rudy Project is dedicated to continuous improvement and sustainable development, ensuring our products and practices contribute positively to the environment and society.



We support reforestation and the restoration of natural habitats through various initiatives. For example, our participation in "One Tree, One Product" reflects our commitment to preserving outdoor environments. Rudy Project is dedicated to ensuring that future generations can enjoy and benefit from healthy, sustainable ecosystems.



Partnerships are crucial for us. We collaborate with organizations such as Confindustria Veneto Est and work with ambassadors like Sonny Colbrelli to drive positive change and achieve sustainable development goals. Through these collaborations, we strengthen our efforts towards sustainability and community development.

sustainable development





eyewear lens families

impactx[®]

UNBREAKABLE PHOTOCROMIC OPTICS



ImpactX[®] the most advanced technological solution in the field of vision protection.

p.18 for futher informations



impactrx[®]

SPORTS PRESCRIPTIONS



ImpactRX[®] the most advanced technological solution in the field of vision protection.

p.81 for futher informations

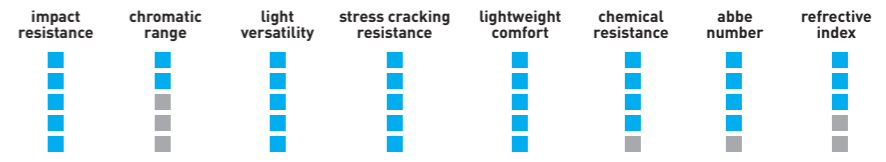

POLAR 3FX HDR



Polar3FX HDR technology eliminates glare providing superior visual comfort, enhanced contrast and contours. In addition, the new Polar3FX lenses incorporate the HDR (high dynamic range) filter to further define contrast and color perception.

p.23 for futher informations



RP OPTICS



RP Optics lenses protect against harmful UV rays up to 400 nm and offer a range of over 30 available colors. Ideal for athletes and weekend warriors who demand performance but accept no compromise when it comes to appearance.

p.25 for futher informations

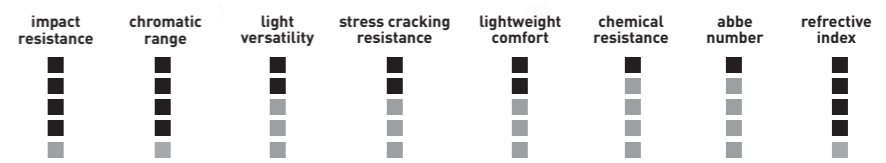

BUILDING ON THE SUCCESS OF IMPACTX® TECHNOLOGY AND FOLLOWING YEARS OF EXTENSIVE LABORATORY RESEARCH AND FIELD TESTS WITH PROFESSIONAL ATHLETES, RUDY PROJECT PROUDLY UNVEILS IMPACTX® 2, A BREAKTHROUGH COLLECTION OF TECHNICAL LENSES. THESE LENSES BOAST EXCEPTIONAL PHOTOCHROMIC PROPERTIES, UTILIZING CUTTING-EDGE PARTICLES FOR UNMATCHED CLIMATIC MANAGEMENT TECHNOLOGY.

IMPACTX® 2 LENSES ADAPT RAPIDLY, TRANSITIONING FROM LOW TO HIGH LIGHT TRANSMISSION IN JUST A FEW SECONDS. THEY CAN ALSO BE TAILORED TO ACHIEVE A CUSTOM COLOR FROM AN INITIALLY CLEAR STATE. THIS REMARKABLE FEATURE ENHANCES CONTRAST, EVEN IN DARKER CONDITIONS, IMPROVING VISUAL ACUITY AND DEPTH PERCEPTION FOR A SUPERIOR VIEWING EXPERIENCE.

IN ADDITION TO THEIR OUTSTANDING VISUAL PERFORMANCE, IMPACTX® 2 LENSES PROVIDE UNPARALLELED EYE PROTECTION. THEY SHIELD THE EYES FROM HARMFUL ELEMENTS, ENSURING SAFETY AND COMFORT DURING VARIOUS OUTDOOR ACTIVITIES. RUDY PROJECT'S COMMITMENT TO INNOVATION AND EXCELLENCE IS EVIDENT IN IMPACTX® 2, OFFERING ATHLETES AND OUTDOOR ENTHUSIASTS THE PERFECT COMBINATION OF ADVANCED TECHNOLOGY, FUNCTIONALITY, AND STYLE.

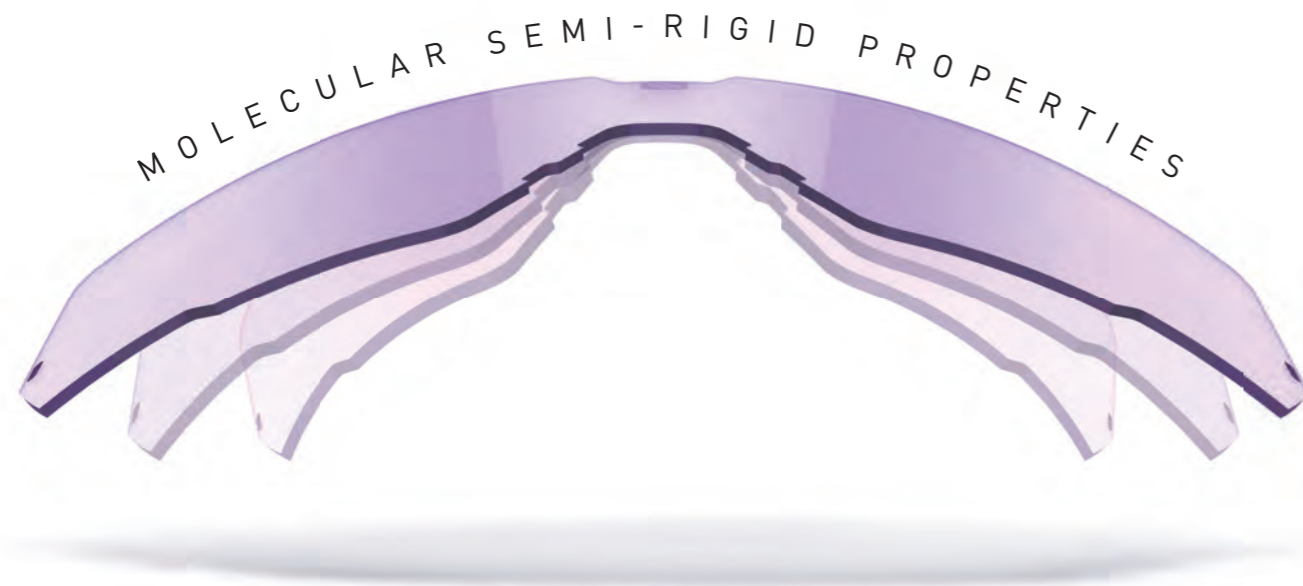

ImpactX technology

GUARANTEED | UNBREAKABLE FOR LIFE

Experience the unbeatable durability of ImpactX® lenses, exclusively designed for Rudy Project. These semi-rigid lenses provide ultimate eye protection against impacts, chemicals, and atmospheric elements while minimizing injury risks. Ideal for sports enthusiasts seeking enhanced safety and performance.



PHOTOCHROMIC | TECHNOLOGY

ImpactX photochromic lenses by Rudy Project offer seamless adaptation to lighting conditions, ensuring perfect visibility and protection. With quick responsiveness, unmatched durability, and complete UV protection, these lenses are ideal for sports enthusiasts and outdoor adventurers.



ULTIMATE | CLARITY

ImpactX® lenses outperform polycarbonate with a lower refraction index, reduced internal stress, and lower chromatic dispersion, providing higher definition and sharper images. The minimized surface reflection and "rainbow effect" deliver a superior visual experience for sports and outdoor enthusiasts.

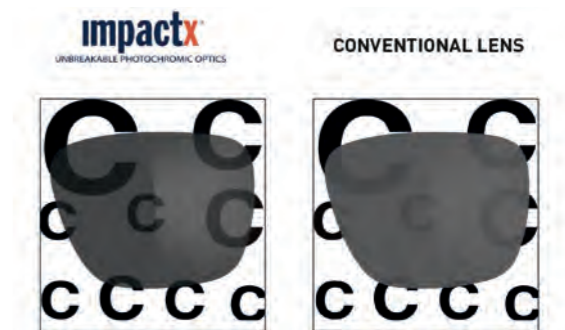

LIGHTWEIGHT

ImpactX® lenses excel in performance, being 16% lighter than CR-39 and 10% lighter than polycarbonate. With lower internal stress and chromatic dispersion, these lenses provide sharper images, higher definition, and reduced "rainbowing" for enhanced visual comfort. Experience state-of-the-art photochromic and polarized technology for exceptional weather management and a superior eye-wear experience.





ImpactX collection lens

impactx[®]
UNBREAKABLE PHOTOCROMIC OPTIC

impactx 2 laser crimson

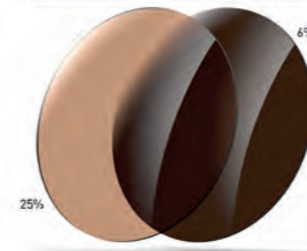

☞ 25% - 6% | Cat. 2/4

NOT SUITABLE FOR DRIVING

impactx 2 black

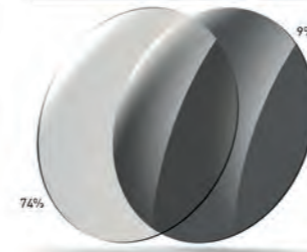

☞ 74% - 9% | Cat. 1/3

impactx 2 laser black

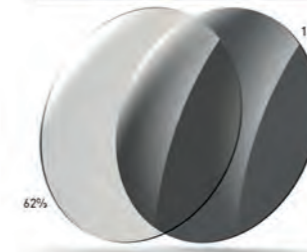

☞ 62% - 13% | Cat. 1/3

impactx 2 red

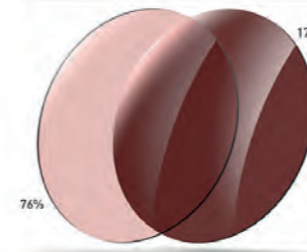

☞ 76% - 17% | Cat. 1/3

impactx 2 laser red

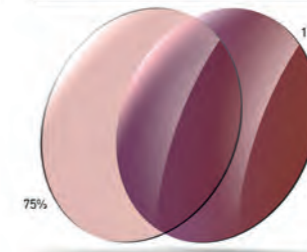

☞ 75% - 16% | Cat. 1/3

impactx 2 laser purple

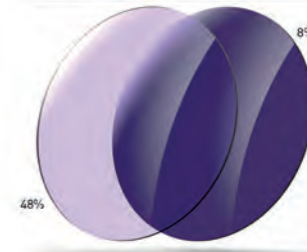

☞ 48% - 8% | Cat. 1/3

ImpactX collection lens





NAKED EYES

NON POLARIZED LENSES

POLARIZED LENSES

POLAR 3FX HDR

polar 3fx HDR | technology

The POLAR 3FX lenses features the HDR filter which is fine tuned to maximize your safety by improving contrast in urban, mountain and road bike environments.

The result is bright and comfortable vision, sharper details perception and brighter colors with considerable reduction in eye fatigue. The POLAR 3FX Multilaser lenses are available in a vast array of colors allowing to benefit from they superior visual comfort and to choose the color which best suits for your style.

Our POLAR 3FX technology protects your eyes from harmful UV rays and eliminates glare by selectively filtering non harmful wavelengths through the lens. POLAR 3FX technology is designed to filter glare from car headlights, sun rays and the refracted light on wet or shiny surfaces like water and snow.



POLAR 3FX HDR MULTILASER BLUE

☞ 18% | Cat.3



POLAR 3FX HDR MULTILASER RED

☞ 16% | Cat.3



POLAR 3FX GREY*

☞ 10,8 % | Cat.3



POLAR 3FX HDR MULTILASER GREEN

☞ 16% | Cat.3

* not available with HDR technology

HDR TECHNOLOGY

The HDR filter is designed to boost your color experience by tuning the wavelength of the light passing through the lens. By actively refining the intensity of various wavelengths of light and by optimizing the visible, the HDR filter provides extraordinary visual performance. In addition to a maximized chromatic range, benefits include superior perception, sharper image and unparalleled contrast definition.

3FX COATINGS

This state-of-the-art coating has been developed to make Polar3FX lenses tougher and more durable. The 3FX coating is a hydrophobic barrier which minimizes the formation of smudges. This treatment is designed to enable water slipping on the surface, to prevent stains and fingerprints and to make cleaning easier.

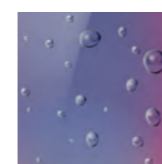

Hydro / Oleo treatment



Easy cleaning



Preventing stain and fingerprints

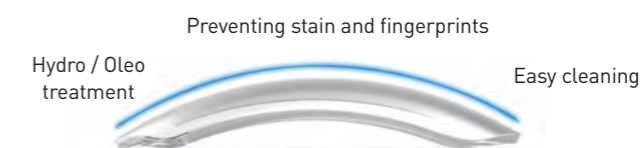



For particular light conditions, Rudy Project offers technically advanced specialty lenses with high visual quality tailored to your needs. The various lenses enable you to perform and excel in any light or atmospheric condition you may encounter. RP Optics is a design philosophy that aims to improve visual performance and eye protection by means of selective lenses with high optical and mechanical performance, combined with the most advanced technologies and scientific applications. Our lens program has features common to every type of lens, such as neutralizing ultraviolet radiation completely up to 400 nm (UV 400 Protection), and maintains colors integrity even with the dark filters. We believe it is not enough to protect the eyes from hazardous radiation and external agents. It also important to enhance visual acuity and minimize distortion, while offering high quality optics suitable for sports. In some extreme conditions an athlete must rely on technologies to enhance performance and minimize distractions. For this reason, we have expanded the range of filters with specific treatments including antifog, hydrophobic, and photochromic technology.

ALWAYS AT THE FOREFRONT OF TECHNOLOGY, OUR LENSES GUARANTEE VISUAL ACUITY AND PHYSICAL PROTECTION OF THE EYE. HIGH VISUAL QUALITY LENSES HAVE THE FOLLOWING PROPERTIES/BENEFITS:

• reduce glare / enhance contrast



• protect from ultraviolet rays



• protect against external agents.





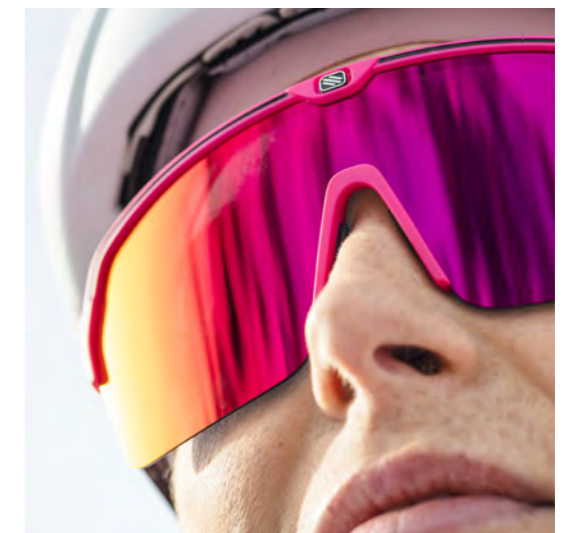



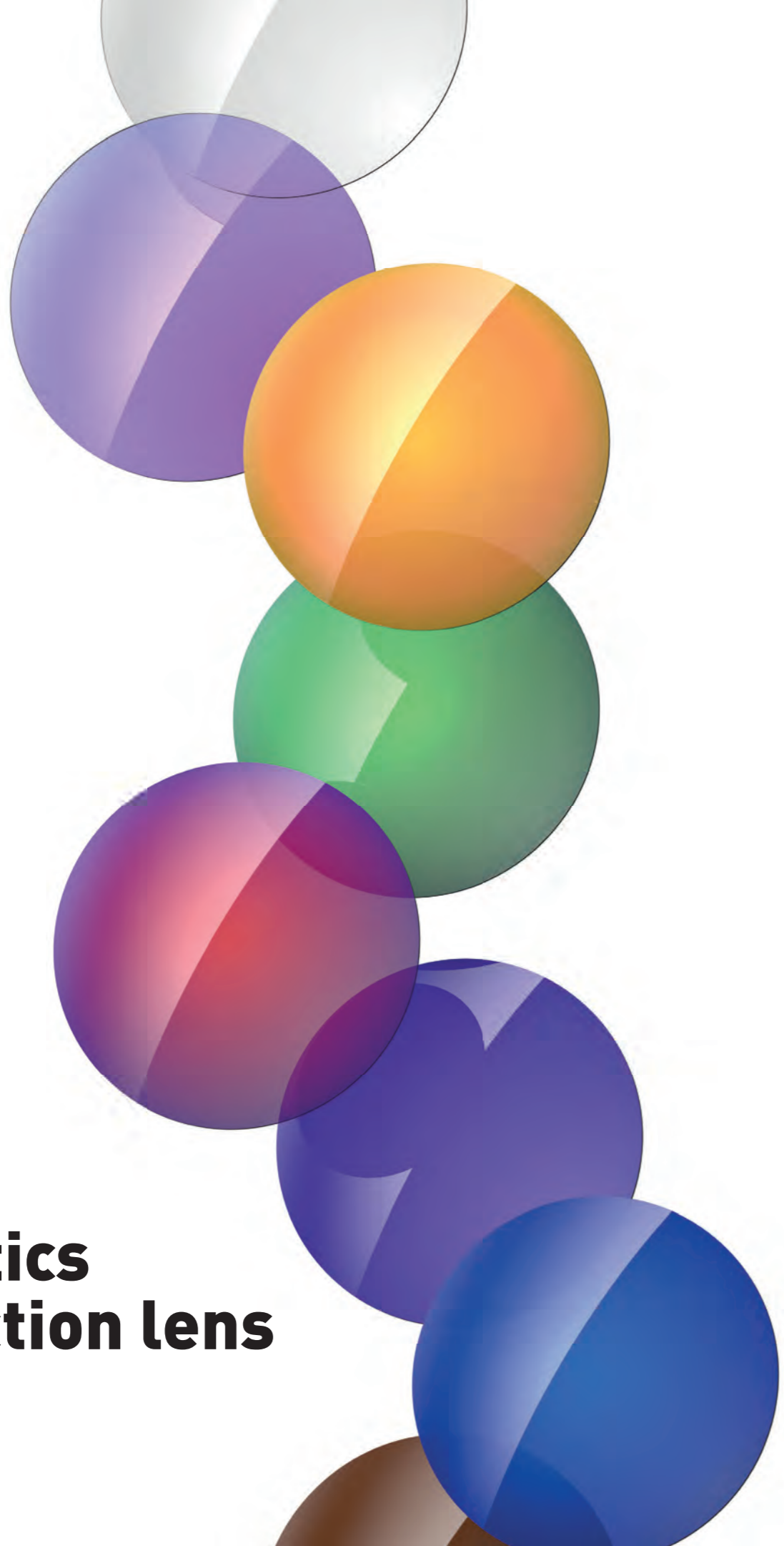

















• ensure true vision without distortion of colors



rp optics
technology



THIS TABLE ILLUSTRATES THE STANDARDS OF LUMINOUS TRANSMITTANCE OF ALL THE RP OPTICS LENSES. THE VALUES SLIGHTLY VARY FROM THE BENCHMARK SHOWN IN THE TABLE ACCORDING TO THE LENS MODEL. PLEASE REFER TO THE PACKAGING LABEL FOR THE EXACT FIGURES.

	ACTION BROWN ☾ 18% Cat.3 ☀ ☁ ☁ LE 22		SMOKE BLACK ☾ 11% Cat.2 ☀ ☁ ☁ LE 10
	GREEN ☾ 11% Cat.3 ☀ ☁ ☁ LE 01		SMOKE BLACK DEG ☾ 13% Cat.3 ☀ ☁ ☁ LE 51
	HI-ALTITUDE not suitable for driving ☾ 5% Cat.4 ☀ LE 98		TRANSPARENT ☾ 91% Cat.0 ☀ ☁ ☁ ☆ LE 11
	LASER BLACK ☾ 11% Cat.3 ☀ LE 09		MULTILASER OSMIUM ☾ 15% Cat.3 ☀ ☁ ☁ ☁ LE 34
	LASER COPPER ☾ 23% Cat.2 LE 08		MULTILASER YELLOW ☾ 10% Cat.3 ☀ ☁ ☁ ☁ LE 05
	LASER GREEN ☾ 22% Cat.3 ☀ LE 32		MULTILASER RED ☾ 15% Cat.3 ☀ LE 38
	MULTILASER ORANGE ☾ 13% Cat.3 ☀ ☁ ☁ LE 40		MULTILASER ROSE ☾ 14% Cat.3 ☀ LE 67
	MULTILASER BLUE ☾ 13% Cat.3 ☀ ☁ ☁ LE 39		MULTILASER ROSE GOLD ☾ 14% Cat.3 ☀ LE 54
	MULTILASER DEEP BLUE ☾ 17% Cat.3 ☀ ☁ ☁ LE 58		MULTILASER SUNSET ☾ 14% Cat.3 ☀ LE 52
	MULTILASER GOLD ☾ 14% Cat.3 ☀ ☁ ☁ LE 57		MULTILASER VIOLET ☾ 12,2% Cat.3 ☀ LE 42
	MULTILASER GREEN ☾ 14% Cat.3 ☀ ☁ ☁ LE 41		RACING RED ☾ 36,9% Cat.2 ☀ ☁ ☁ ☁ LE 03
	MULTILASER ICE ☾ 13% Cat.3 ☀ LE 68		YELLOW ☾ 84% Cat.0 ☀ ☁ ☁ ☁ LE 12

rp optics collection lens



RUDY PROJECT SUNGLASSES ARE LOADED WITH FEATURES THAT MAXIMIZE YOUR COMFORT AND PERFORMANCE. HERE IS A LIST OF TECHNICAL SOLUTIONS THAT MAKE OUR SUNGLASSES THE BEST-IN-THE-WORLD. ON EVERY PRODUCT PAGE OF THE CATALOGUE YOU WILL FIND ICONS THAT REPRESENT THESE FEATURES.



ADAPTIVE TIPS

The Adaptive Tips system is designed to ensure maximum comfort : thanks to its interior bendable stainless steel, the front portion of the tip can be very easily adjusted and the rear portion of the tip naturally flexes without hurting the riders' head when inserted through the helmet vents



ADJUSTABLE NOSEPIECE

Our soft adjustable nose pads offer an exceptional custom fit for any shape of face



ADJUSTABLE TEMPLE

Adjustable temples ensures a fully custom and a perfect grip maximizing the stability of the sunglasses.



COMPRESSION FIT

The wraparound geometry of the Rudy Project performance eyewear delivers a natural compression fit without applying too much pressure on the head increasing comfort and stability



INTERCHANGEABLE BUMPER

The bumpers are colorful rubber inserts placed on the lower edge of the lens and designed to maximize your safety in the event of crash



COUNTER MASK

The vented and padded full-face counter mask provides additional protection from wind and atmospheric elements increasing the safety of the eyes area.



QUICK CHANGE

The Quick Change feature allows you to easily and swiftly change out lenses to manage any light condition and choose the look that suits you best



ELASTIC STRAP

The elastic strap with included head lock is essential to secure your eyewear and retain it while wearing a helmet



TOTAL COMFORT FIT

Featuring ergonomic design, complete adjustability, multiple sizes and smart comfort solutions, our eyewear ensure unparalleled comfort and fit with the physical features of each ethnic group.



VENT CONTROLLER

Rudy Project vent controller is designed to adjust the airflow through the lens to reduce thermal shock, prevent misting, and ensure perfect vision and comfortable ventilation.



PERIPHERAL SHIELDS

The peripheral shields are removable rubber inserts which enhance protection from side light and shocks caused by eventual falls or impacts with rocks or branches.



POWERFLOW

The Power Flow ventilation system reduces the risk of fogging thanks to venting scientifically located on the frame, lens, and temple tips.



RX-ABLE

Most of our models offer prescription solutions to always ensure the best standard of performance for all prescription wearers.



SAFETY PROJECT

Rudy Project eyewear provide superior safety through integrated hinges and soft, thermoplastic elastomers which prevent injuries in the event of falls, impact and collisions.



RILSAN

RILSAN® material is used for injecting frame, made from the oil of the castor bean grown in the Gujarat region of India. The oil is further refined during several steps to produce the primary bio-based raw material in the polymer.

technology features



performance eyewear

TEAM BAHRAIN VICTORIOUS ©SPRINTCYCLINGAGENCY.COM



made in Italy

BASE 5.2
o: 1,27
g: 36

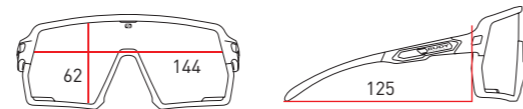

Kelion

- RX SOLUTIONS
- POWERFLOW
- TOTAL COMFORT FIT
- ADJUSTABLE NOSEPIECE
- ADJUSTABLE TEMPLE
- RILSAN

RX SOLUTIONS



OPTICAL INSERT
p. 90
FR 84 00 00

REPLACEMENT LENSES

impactx

LE 85 78 03 ImpactX Photochromic 2 Laser Black
LE 85 75 03 ImpactX Photochromic 2 Laser Purple

RP OPTICS

LE 85 05 03 Multilaser Yellow
LE 85 11 03 Transparent
LE 85 38 03 Multilaser Red
LE 85 41 03 Multilaser Green
LE 85 52 03 Multilaser Sunset

ACCESSORIES

Temple tips Black
FP 50 72 00

Nosepiece Black
FP 85 77 00



IMPACTX®



BLACK GLOSS
ImpactX Photochromic 2 Laser Purple
SP 85 75 42 - 0000



BLACK GLOSS
ImpactX Photochromic 2 Laser Black
SP 85 78 42 - 0000



WHITE GLOSS
ImpactX Photochromic 2 Laser Purple
SP 85 75 69 - 0000



CRYSTAL BLUE
ImpactX Photochromic 2 Laser Black
SP 85 78 77 - 0000

RP OPTICS



NEW
CRYSTAL BLUE GLOSS
Multilaser Yellow
SP 85 05 77 - 0000



NEW
CRYSTAL RED GLOSS
Multilaser Red
SP 85 38 17 - 0002



CRYSTAL ASH
Multilaser Green
SP 85 41 57 - 0000



PINK FLUO MATTE
Multilaser Sunset
SP 85 52 89 - 0000



OLIVE MATTE
Multilaser Yellow
SP 85 05 13 - 0000





made in Italy



BASE 7
o: 1,27
g: 36



Cutline

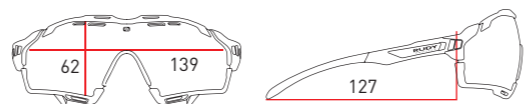
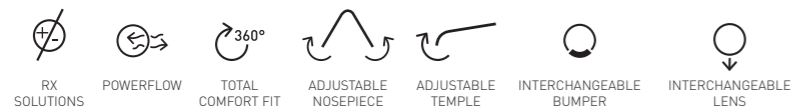

IMPACTX®



NEW
BLACK MATTE
ImpactX Photochromic 2 Laser Purple
SP 63 75 06 - 0001



LAGOON MATTE
ImpactX Photochromic 2 Laser Black
SP 63 78 27 - 0000



LIGHT GREY MATTE
ImpactX Photochromic 2 Laser Black
SP 63 78 97 - 0000



MATTE BLACK
ImpactX Photochromic 2 Black
SP 63 73 06 - 0000



WHITE GLOSS
ImpactX Photochromic 2 Laser Purple
SP 63 75 69 - 0008



CARBONIUM
ImpactX Photochromic 2 Red
SP 63 74 19 - 0001

The photochromic laser coating is developed to reduce lens glare with bright light conditions. Thus, we strongly recommend to use the ImpactX®2 and ImpactRX laser lenses during daylight hours and not at the twilight.

RX SOLUTIONS

impactrx

COLLECTION
p.86



OPTICAL INSERT
p.90
FR 39 00 00

REPLACEMENT LENSES

impactx

LE 63 73 03 ImpactX Photochromic 2 Black
LE 63 74 03 ImpactX Photochromic 2 Red
LE 63 75 03 ImpactX Photochromic 2 Laser Purple
LE 63 78 03 ImpactX Photochromic 2 Laser Black

RP OPTICS

LE 63 11 03 Transparent
LE 63 52 03 Multilaser Sunset
LE 63 58 03 Multilaser Deep Blue
LE 63 68 03 Multilaser Ice

ACCESSORIES

Temple tips Black
FP 50 72 00

Nosepiece IV Black
FP 39 77 08 00 V

Upper Bumper Black
FP 63 58 00

Lower Bumper Black
FP 63 68 00

CUTLINE CHROMATIC FULL CUSTOM KIT
Includes 1 set of temple tips, 1 set of nosepiece, 1 set of emblems.

Black / Chrome emblems
Red Fluo / Black bumpers - Red fluo tips
AC 21 01 86 B

Black / Chrome emblems
White bumpers - Black tips
AC 21 01 88 B

Cutline features 4 different bumpers configurations to meet the riders demands and to customize your look.



RP OPTICS



NEW
CRYSTAL ASH GLOSS
Multilaser Sunset
SP 63 52 57 - 0001



CRYSTAL GLOSS
Multilaser Deep Blue
SP 63 58 96 - 0000



COSMIC BLUE
Multilaser Ice
SP 63 68 94 - 0000



made in italy



BASE 7
o: 1
g: 28



Defender

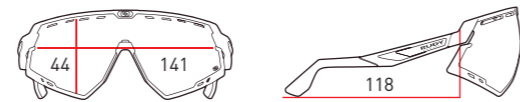
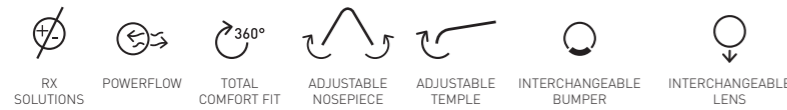

RX SOLUTIONS

impactrx

RX OPTICAL INSERT
p.90
FR 52 00 00

REPLACEMENT LENSES

impactx

LE 52 73 03 ImpactX Photochromic 2 Black
LE 52 74 03 ImpactX Photochromic 2 Red
LE 52 75 03 ImpactX Photochromic 2 Laser Purple
LE 52 78 03 ImpactX Photochromic 2 Laser Black

RP OPTICS

LE 52 05 03 Multilaser Yellow
LE 52 10 03 Smoke Black
LE 52 11 03 Transparent
LE 52 38 03 Multilaser Red

ACCESSORIES

Temple tips Black
FP 52 72 00

Nosepiece Black
FP 52 78 00

Bumper Black
FP 52 58 00

DEFENDER CHROMATIC FULL CUSTOM KIT
Includes 1 set of temple tips, 1 set of nosepiece IX,
1 set of emblems.

Red Fluo rubber
Red Fluo / White emblems
AC 21 01 40 A

Black rubber
Chrome / Black emblems
AC 21 01 62 A

Red Fluo / Black rubber
Emerald Chrome emblems
Black / White emblems
AC 21 02 29 A

IMPACTX®



GLACIER MATTE / BUMPERS AVIO
ImpactX Photochromic 2 Laser Purple
SP 52 75 59 - 0000



BLACK MATTE / BUMPERS RED FLUO
ImpactX Photochromic 2 Red
SP 52 74 06 - 0001



PYOMBO MATTE / BUMPERS BLACK
ImpactX Photochromic 2 Black
SP 52 73 75 - 0000



SAND MATTE / BUMPERS BLACK
ImpactX Photochromic 2 Laser Black
SP 52 78 32 - 0000

RP OPTICS



OLIVE MATTE
Multilaser Yellow
SP 52 05 13 - 0000



EMERALD - WHITE MATTE
Multilaser Red
SP 52 38 23 - 0000



WHITE GLOSS - FADE BLUE BLUE RED STRIPES BUMPERS WHITE
Multilaser Ice
SP 52 68 69 - 0020



BLACK MATTE / BUMPERS BLACK
Smoke Black
SP 52 10 06 - 0000



made in Italy

BASE 7
o: 1,02
g: 29



Turbolence NEW

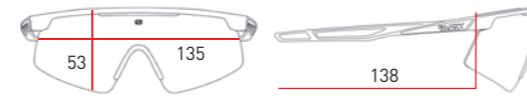

RX SOLUTIONS

impactrx

COLLECTION
p.86



RX OPTICAL INSERT
p.90
FR 39 00 00

REPLACEMENT LENSES

impactx

LE 89 73 03 ImpactX Photochromic 2 Black
LE 89 75 03 ImpactX Photochromic 2 Laser Purple
LE 89 78 03 ImpactX Photochromic 2 Laser Black
LE 89 89 03 ImpactX Photochromic 2 Laser Red

POLAR 3FX HDR

LE 89 65 03 Polar3FX HDR Multilaser Blue

RP OPTICS

LE 89 10 03 Smoke Black
LE 89 42 03 Multilaser Violet
LE 89 05 03 Multilaser Yellow

ACCESSORIES

Nosepiece Black
FP 39 77 08 00 V2

Interface
AC 56 00 48

Elastic cord
AC 56 00 49



IMPACTX®



CHARCOAL MATTE
ImpactX Photochromic 2 Laser Red
SP 89 89 38 - 0000

CRYSTAL ASH
ImpactX Photochromic 2 Laser Black
SP 89 78 33 - 0000

WHITE MATTE
ImpactX Photochromic 2 Laser Purple
SP 89 75 58 - 0000

BLACK MATTE
ImpactX Photochromic 2 Black
SP 89 73 06 - 0001

WITHOUT INTERFACE AND ELASTIC CORD

CHARCOAL MATTE
ImpactX Photochromic 2 Laser Red
SP 89 89 38 - N000

CRYSTAL ASH
ImpactX Photochromic 2 Laser Black
SP 89 78 33 - N000

WHITE MATTE
ImpactX Photochromic 2 Laser Purple
SP 89 75 58 - N000

BLACK MATTE
ImpactX Photochromic 2 Black
SP 89 73 06 - N001

POLAR 3FX / HDR



BLUE NAVY MATTE
Polar3FX ASW Multilaser Blue
SP 89 65 47 - 0000

HYDROSHIELD COATING

Our advanced coating technology enhances the smoothness and increases the surface tension of the lens. This causes water, oil, and other liquids to form into beads upon contact, significantly reducing friction with the lens surface. The result is an automatic sliding or "running beads" effect, ensuring a clear and unobstructed view at all times.

RP OPTICS



CRYSTAL ASH
Multilaser Violet
SP 89 42 33 - 0000

BLACK MATTE
Smoke black
SP 89 10 06 - 0000

CRYSTAL BLUE AVIO / APPLE GREEN FADE GLOSS
Multilaser Yellow
SP 89 05 02 - 0000

WITHOUT INTERFACE AND ELASTIC CORD

CRYSTAL ASH
Multilaser Violet
SP 89 42 33 - N000

BLACK MATTE
Smoke black
SP 89 10 06 - N000

CRYSTAL BLUE AVIO / APPLE GREEN FADE GLOSS
Multilaser Yellow
SP 89 05 02 - N000



made in Italy

BASE 8
o: 1,02
g: 29

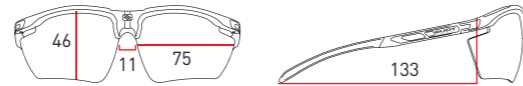

Magnus



RX SOLUTIONS

impactrx

COLLECTION
p.86



OPTICAL DOCK
p.92
FR 53 OD 87



RX OPTICAL INSERT
p.90
FR 70 00 00

REPLACEMENT LENSES

impactrx

LE 75 73 03 ImpactX Photochromic 2 Black
LE 75 74 03 ImpactX Photochromic 2 Red
LE 75 75 03 ImpactX Photochromic 2 Laser Purple
LE 75 89 03 ImpactX Photochromic 2 Laser Red

RP OPTICS

LE 75 10 03 Smoke Black

ACCESSORIES

Temple tips Black
FP 50 72 00

Nosepiece XI Black
FP 45 77 00 V 1

MAGNUS CHROMATIC FULL CUSTOM KIT
Includes 1 set of temple tips, 1 set of nosepiece IV, 1 set of emblems.

Red
AC 21 02 13 A

IMPACTX®



NEW
FROZEN BLUE AVIO MATTE
ImpactX Photochromic 2 Black
SP 75 73 31 - 0000



WHITE GLOSS
ImpactX Photochromic 2 Laser Purple
SP 75 75 69 - 0000



BLACK MATTE
ImpactX Photochromic 2 Black
SP 75 73 06 - 0000



CARBONIUM
ImpactX Photochromic 2 Laser Red
SP 75 89 19 - 0000



CHARCOAL MATTE
ImpactX Photochromic 2 Red
SP 75 74 38 - 0000

RP OPTICS



LIGHT TEAL MATTE
Multilaser Gold
SP 75 57 64 - 0000



BLUE NAVY MATTE
Multilaser Blue
SP 75 39 47 - 0000



BLACK MATTE
Smoke Black
SP 75 10 06 - 0001



made in italy

BASE 8
o: 1,05
g: 30



Nyad NEW

RX SOLUTIONS
 SIDE SHIELDS

RILSAN

RX SOLUTIONS

impactrx

COLLECTION
 p.86



RX OPTICAL INSERT
 p.90
FR 87 00 00

ACCESSORIES

SIDE SHIELDS

Black Matte
FP 92 62 00



IMPACTX®



BLACK MATTE
ImpactX Photochromic 2 Black
SP 92 73 06 - SH00

CERTIFIED Z87.1+



BLACK MATTE
ImpactX Photochromic 2 Laser Purple
SP 92 75 06 - 0000



BLUE NAVY MATTE
ImpactX Photochromic 2 Laser Crimson
SP 92 72 47 - 0000

POLAR 3FX / HDR



BLACK MATTE
Polar3FX Grey
SP 92 59 06 - 0000



BLUE NAVY MATTE
Polar 3FX HDR Multilaser Red
SP 92 62 47 - 0000

RP OPTICS



CHARCOAL MATTE
Hi-Altitude
SP 92 98 38 - 0000



BLACK MATTE
Smoke Black
SP 92 10 06 - SH00

CERTIFIED Z87.1+



CRYSTAL ASH GLOSS
Multilaser Green
SP 92 41 57 - 0000



made in italy

BASE 8
o: 1,38
g: 39



Stardash

- RX SOLUTIONS
- SIDE SHIELDS
- ADJUSTABLE NOSEPIECE
- ADJUSTABLE TEMPLE
- RILSAN

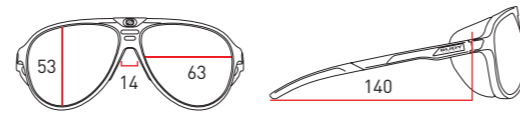

IMPACTX®



BLUE NAVY MATTE
ImpactX Photochromic 2 Laser Crimson
SP 81 72 47 - 0000



WHITE GLOSS
ImpactX Photochromic 2 Laser Crimson
SP 81 72 69 - 0000

RP OPTICS



CHARCOAL MATTE
Hi-Altitude
SP 81 98 38 - 0000



GLACIER MATTE
Multilaser Osmium
SP 81 34 59 - 0000



BLACK MATTE
Smoke
SP 81 10 06 - 0000



BLUE NAVY MATTE
Multilaser Red
SP 81 38 47 - 0001

RX SOLUTIONS



RX OPTICAL INSERT
p.90
FR 70 00 00

ACCESSORIES

Temple tips Black
FP 64 72 00

Nosepiece IV Black
FP 39 77 08 00 V

Side shields Black
FP 81 62 00



SIDE SHIELD CONFIGURATION



NO SIDE SHIELD CONFIGURATION





made in italy



BASE 8
o: 0,91
g: 26



Rydon



RX SOLUTIONS

impactrx

COLLECTION
p.86



RX DIRECT CLIPS
p.94
FR 80 00 02 A



OPTICAL DOCK
p.92
FR 79 0D 87



RX OPTICAL INSERT
p.90
FR 70 00 00



READERS COLLECTION
p.98

REPLACEMENT LENSES

impactrx

LE 79 73 ImpactX Photochromic 2 Black
LE 79 74 ImpactX Photochromic 2 Red
LE 79 75 ImpactX Photochromic 2 Laser Purple
LE 79 75 G ImpactX Photochromic 2 Laser Purple Golf
LE 79 78 ImpactX Photochromic 2 Laser Black
LE 79 89 ImpactX Photochromic 2 Laser Red

POLAR 3FX HDR

LE 79 59 X Polar3FX Grey
LE 79 61 Polar 3FX HDR Multilaser Green
LE 79 65 Polar 3FX HDR Multilaser Blue

RP OPTICS

LE 79 03 Racing Red
LE 79 08 Laser Copper
LE 79 09 Laser Black
LE 79 10 Smoke Black
LE 79 11 Transparent
LE 79 12 Yellow
LE 79 22 Action Brown
LE 79 34 Multilaser Osmium
LE 79 38 Multilaser Red
LE 79 39 Multilaser Blue
LE 79 58 Multilaser Deep Blue

ACCESSORIES

Temple tips Black
FP 53 72 00

Nosepiece IV Black
FP 39 77 08 00 V

RYDON CHROMATIC FULL CUSTOM KIT

Includes 1 set of temple tips, 1 set of nosepiece IV, 1 set of emblems.

White - White/Chrome
Grey / Black
AC 21 01 33 A

IMPACTX®



NEW
FROZEN BLUE AVIO MATTE
ImpactX Photochromic 2 Black
SP 53 73 31 - 0000



LIGHT GREY MATTE
ImpactX Photochromic 2 Laser Purple
SP 53 75 97 - 0000



PACIFIC BLUE MATTE
ImpactX Photochromic 2 Black
SP 53 73 49 - 0000



CARBONIUM
ImpactX Photochromic 2 Laser Red
SP 53 89 19 - 0000



WHITE CARBONIUM
ImpactX Photochromic 2 Black
SP 53 73 21 - 0000



FROZEN ASH
ImpactX Photochromic 2 Laser Black
SP 53 78 87 - 0000



BLACK MATTE
ImpactX Photochromic 2 Black
SP 53 73 06 - 0000



FROZEN ASH
ImpactX Photochromic 2 Red
SP 53 74 87 - 0002



PACIFIC BLUE MATTE
ImpactX Photochromic 2 Red
SP 53 74 49 - 0R00



BLACK MATTE | GOLF
ImpactX Photochromic 2 Laser Purple
SP 53 75 06 G 00 00



MATTE BLACK
ImpactX Photochromic 2 Black
SP 53 73 06-SH00

CERTIFIED Z87.1+

POLAR 3FX / HDR



BLACK MATTE
Polar3FX Grey
SP 53 59 06 - 0000



CARBON
Polar 3FX HDR Multilaser Blue
SP 53 65 14 - 0000



CARBON
Polar 3FX HDR Multilaser Green
SP 53 61 14 - 0000

RP OPTICS



GLACIER MATTE
Multilaser Osmium
SP 53 34 59 - 0000



GRAPHITE MULTICOLOR RED
Multilaser Red
SP 53 38 98 - 0001



MATTE BLACK
Smoke Black
SP 53 10 06 - SH10



CRYSTAL ASH
Multilaser Deep Blue
SP 53 58 57 - 0001

CERTIFIED Z87.1



BLACK MATTE
Smoke Black
SP 53 10 06 - 0000

Laser Black
SP 53 09 06 - 0000



BLACK MATTE
Racing Red
+ Laser Copper
+ Action Brown
+ Yellow
+ Transparent
SP 53 03 06 - S005



CARBON
Smoke Black
SP 53 10 14 - 0000



BLUE NAVY MATTE
Multilaser Blue
SP 53 39 47 - 0000



made in italy

BASE 8
o: 0,88
g: 25



Rydon Slim

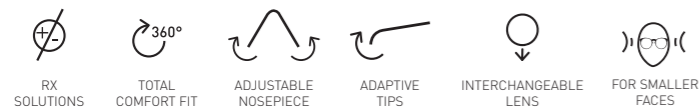

RX SOLUTIONS

impactrx

COLLECTION
p.86



OPTICAL DOCK
p.92
FR 54 0D 87



RX OPTICAL INSERT
p.90
FR 70 00 00

REPLACEMENT LENSES

impactrx

LE 54 73 03 ImpactX Photochromic 2 Black
LE 54 75 03 ImpactX Photochromic 2 Laser Purple
LE 54 78 03 ImpactX Photochromic 2 Laser Black
LE 54 89 03 ImpactX Photochromic 2 Laser Red

POLAR 3FX HDR

LE 54 59 03 Polar3FX Grey

RP OPTICS

LE 54 10 03 Smoke Black
LE 54 11 03 Transparent
LE 54 52 03 Multilaser Sunset

ACCESSORIES

Temple tips Black
FP 53 72 00

Nosepiece IV Black
FP 39 77 08 00 V

RYDON CHROMATIC FULL CUSTOM KIT

Includes 1 set of temple tips, 1 set of nosepiece IX, 1 set of emblems.

White - White/Chrome
Grey / Black
AC 21 01 33 A

Fuxia - White/Black
Fuxia / Black
AC 21 01 36 A

Rubin - rubin /Chrome
Rubin / Black
AC 21 01 66 A

IMPACTX®



LIGHT GREY MATTE
ImpactX Photochromic 2 Laser Purple
SP 54 75 97 - 0000



WHITE CARBONIUM
ImpactX Photochromic 2 Black
SP 54 73 21 - 0000



FROZEN ASH
ImpactX Photochromic 2 Laser Black
SP 54 78 87 - 0000



BLACK GLOSS
ImpactX Photochromic 2 Black
SP 54 73 42 - 0000



PACIFIC BLUE MATTE
ImpactX Photochromic 2 Black
SP 54 73 49 - 0000



BLACK MATTE
ImpactX Photochromic 2 Black
SP 54 73 06 - 0000



CARBONIUM
ImpactX Photochromic 2 Laser Red
SP 54 89 19 - 0000

POLAR 3FX / HDR



BLACK MATTE
Polar 3FX Grey
SP 54 59 06 - 0000

RP OPTICS



CRYSTAL ASH
Multilaser Sunset
SP 54 52 57 - 0001



WHITE GLOSS
Multilaser Gold
SP 54 57 69 - 0000



GLACIER MATTE
Multilaser Osmium
SP 54 34 59 - 0000



BLACK MATTE
Smoke Black
SP 54 10 06 - 0000



BASE 5
o: 0,9
g: 26



Spinshield

360°
TOTAL COMFORT FIT

IMPACTX®



WHITE MATTE
ImpactX Photochromic 2 Laser Purple
SP 72 75 58 - 0005



BLACK MATTE
ImpactX Photochromic 2 Laser Black
SP 72 78 06 - 0003



PACIFIC BLUE MATTE
ImpactX Photochromic 2 Laser Black
SP 72 78 49 - 0000

RP OPTICS



NEW
CRYSTAL BLUE AVIO / APPLE GREEN FADE GLOSS
Multilaser Yellow
SP 72 05 30 - 0000



NEW
CRYSTAL ASH GLOSS
Multilaser Sunset
SP 72 52 33 - 0002



NEW
PINK FLUO / BLACK MATTE
Multilaser Red
SP 72 38 90 - 0001



CRYSTAL AZUR
Multilaser Green
SP 72 41 68 - 0000



BLACK MATTE
Multilaser Blue
SP 72 39 06 - 0002



BLACK MATTE
Smoke Black
SP 72 10 06 - 0000



BLACK MATTE
Multilaser Red
SP 72 38 06 - 0002



WHITE MATTE
Multilaser Gold
SP 72 57 58 - 0000



BASE 5
o: 0,9
g: 26



Spinshield Air

RX SOLUTIONS
360°
TOTAL COMFORT FIT

IMPACTX®



WHITE MATTE
ImpactX Photochromic 2 Laser Purple
SP 84 75 58 - 0001



BLACK MATTE
ImpactX Photochromic 2 Laser Black
SP 84 78 06 - 0003

RX SOLUTIONS

impactrx



RX OPTICAL INSERT
p.90
FR 84 00 00

RP OPTICS



NEW
CRYSTAL LILAC GLOSS
Multilaser Gold
SP 84 57 65 - 0000



BLACK MATTE
Smoke Black
SP 84 10 06 - 0000



PINK FLUO MATTE
Multilaser Red
SP 84 38 90 - 0001



CRYSTAL ASH
Multilaser Orange
SP 84 40 33 - 0000



BLACK MATTE
Multilaser Red
SP 84 38 06 - 0002



BLACK MATTE
Multilaser Blue
SP 84 39 06 - 0003



WHITE MATTE
Multilaser Gold
SP 84 57 58 - 0000



made in italy

BASE 6
o: 0,88
g: 26

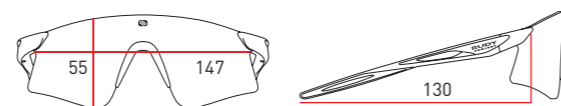

Astral



RX SOLUTIONS



OPTICAL INSERT
 p.90
FR 84 00 00

ACCESSORIES

Nosepiece IV Black
FP 39 77 08 00 V1



RP OPTICS

NEW

**APPLE GREEN FADE GLOSS/
CRYSTAL BLUE AVIO**
Multilaser Yellow
SP 88 05 30 - 0000

BLACK MATTE
Smoke Black
SP 88 10 06 - 0000

EMERALD FADE MATTE
Multilaser Orange
SP 88 40 23 - 0000

METAL TITANIUM MATTE
Multilaser Sunset
SP 88 52 92 - 0000

WHITE MATTE
Multilaser Blue
SP 88 39 58 - 0000

CRYSTAL ASH
Multilaser Green
SP 88 41 33 - 0000

PINK FLUO FADE MATTE
Multilaser Ice
SP 88 68 90 - 0000





made in Italy

BASE 6
o: 0,98
g: 28



Astral X NEW

- RX SOLUTIONS
- ADJUSTABLE NOSEPIECE
- RILSAN

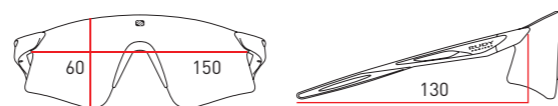

RX SOLUTIONS

impactrx



RX OPTICAL INSERT
p.90
FR 84 00 00

ACCESSORIES

Nosepiece IV Black
FP 39 77 08 00 V1



RP OPTICS



BLACK MATTE
Multilaser Red
SP 94 38 06 - 0000



CRYSTAL ASH GLOSS
Multilaser Green
SP 94 41 33 - 0000



WHITE MATTE
Multilaser Rose Gold
SP 94 54 58 - 0001



LIGHT TEAL MATTE
Multilaser Osmium
SP 94 34 64 - 0000



CRYSTAL LILAC GLOSS
Multilaser Rose Gold
SP 94 54 65 - 0000





made in Italy



BASE 8
o: 1,1
g: 30

Sirius

- RX SOLUTIONS
- POWERFLOW
- TOTAL COMFORT FIT
- ADJUSTABLE NOSEPIECE
- RILSAN
- FOR SMALLER FACES

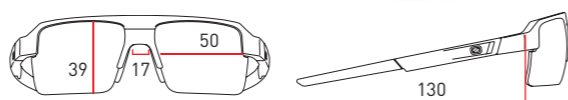

RX SOLUTIONS

impactrx

COLLECTION
p.86



RX OPTICAL INSERT
p.90
FR 87 00 00



OPTICAL DOCK
p.92
FR 87 0D 06

REPLACEMENT LENSES

impactrx

LE 87 73 03 ImpactX Photochromic 2 Black
LE 87 75 03 ImpactX Photochromic 2 Laser Purple
LE 87 78 03 ImpactX Photochromic 2 Laser Black

POLAR 3FX HDR

LE 87 59 03 Polar3FX Grey

RP OPTICS

LE 87 10 03 Smoke
LE 87 38 03 Multilaser Red
LE 87 42 03 Multilaser Violet
LE 87 52 03 Multilaser Sunset

ACCESSORIES

Temple tips Black
FP 87 72 00

Nosepiece Black
FP 85 77 00



IMPACTX®



BLACK MATTE
ImpactX Photochromic 2 Black
SP 87 73 06 - 0000



COSMIC BLUE
ImpactX Photochromic 2 Laser Black
SP 87 78 94 - 0000



WHITE GLOSS
ImpactX Photochromic 2 Laser Purple
SP 87 75 69 - 0000

POLAR 3FX / HDR



BLACK MATTE
Polar 3FX Grey
SP 87 59 06 - 0000

RP OPTICS



BLACK MATTE
Smoke black
SP 87 10 06 - 0000



CRYSTAL ASH
Multilaser Violet
SP 87 42 57 - 0000



WHITE GLOSS
Multilaser Red
SP 87 38 69 - 0000



BLACK MATTE
Multilaser Sunset
SP 87 52 06 - 0001





made in Italy

BASE 8
o: 1,09
g: 31



Deltabeat

- RX SOLUTIONS
- VENT CONTROLLER
- TOTAL COMFORT FIT
- ADJUSTABLE NOSEPIECE
- RILSAN

RX SOLUTIONS

OPTICAL DOCK
p.92
FR 74 0D 87

RX OPTICAL INSERT
p.90
FR 70 00 00

REPLACEMENT LENSES

impactx
LE 74 73 03 ImpactX Photochromic 2 Black
LE 74 74 03 ImpactX Photochromic 2 Red
LE 74 75 03 ImpactX Photochromic 2 Laser Purple

RP OPTICS
LE 74 10 03 Smoke Black
LE 74 38 03 Multilaser Red
LE 74 52 03 Multilaser Sunset

ACCESSORIES

Nosepiece IV Black
FP 45 77 00 V 3



IMPACTX®

NEW

BLACK MATTE
ImpactX Photochromic 2 Laser Purple
SP 74 75 06 - 0001

BLACK MATTE
ImpactX Photochromic 2 Black
SP 74 73 06 - 0000

CHARCOAL MATTE
ImpactX Photochromic 2 Red
SP 74 74 38 - 0000

LIGHT GREY
ImpactX Photochromic 2 Black
SP 74 73 97 - 0000

WHITE GLOSS
ImpactX Photochromic 2 Laser Purple
SP 74 75 69 - 0000

RP OPTICS

CRYSTAL ASH
Multilaser Sunset
SP 74 52 33 - 0000

BLACK MATTE
Smoke Black
SP 74 10 06 - 0000

CHARCOAL MATTE
Multilaser Red
SP 74 38 38 - 0000

PACIFIC BLUE MATTE
Multilaser Ice
SP 74 68 49 - 0000





made in italy



BASE 8
o: 0,9
g: 26



Propulse



RX SOLUTIONS

impactrx

COLLECTION
p.86



RX OPTICAL INSERT
p.90
FR 70 00 00



READERS COLLECTION
p.98

REPLACEMENT LENSES

impactrx

LE 62 73 03 ImpactX Photochromic 2 Black
LE 62 74 03 ImpactX Photochromic 2 Red
LE 62 75 03 ImpactX Photochromic 2 Laser Purple

RP OPTICS

LE 62 09 03 Laser Black
LE 62 10 03 Smoke Black
LE 62 11 03 Transparent
LE 62 38 03 Multilaser Red
LE 62 40 03 Multilaser Orange

ACCESSORIES

Temple tips Black
FP 62 72 00

Nosepiece XI Black
FP 45 77 00 V 1

PROPULSE CHROMATIC FULL CUSTOM KIT

Includes 1 set of temple tips, 1 set of nosepiece V, 1 set of emblems and 1 multitool.

Rubin
AC 21 01 78 A

IMPACTX®

NEW

BLACK MATTE
ImpactX Photochromic 2 Laser Purple
SP 62 75 06 - 0001

LIGHT GREY MATTE
ImpactX Photochromic 2 Black
SP 62 73 97 - 0000

WHITE GLOSS
ImpactX Photochromic 2 Laser Purple
SP 62 75 69 - 0000

BLACK MATTE
ImpactX Photochromic 2 Black
SP 62 73 06 - 0000

BLACK MATTE
ImpactX Photochromic 2 Red
SP 62 74 06 - 0000

PACIFIC BLUE MATTE
ImpactX Photochromic 2 Red
SP 62 74 49 - 0000

RP OPTICS

WHITE GLOSS
Laser Black
SP 62 09 69 - 0000

CHARCOAL MATTE
Multilaser Red
SP 62 38 38 - 0000

CRYSTAL ASH
Multilaser Deep Blue
SP 62 58 33 - 0000

BLACK MATTE
Smoke Black
SP 62 10 06 - 0000

BLUE NAVY MATTE
Multilaser Orange
SP 62 40 47 - 0000



made in italy

BASE 8
o: 1,38
g: 39

AGENT Q STEALTH
BASE 8
o: 0,91
g: 26

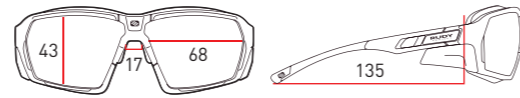

Agent Q



RX SOLUTIONS

impactrx

COLLECTION
p.86

RX OPTICAL INSERT
p.90
FR 07 00 00

REPLACEMENT LENSES

impactrx

LE 70 73 03 ImpactX Photochromic 2 Black
LE 70 72 03 ImpactX Photochromic 2 Laser Crimson

RP OPTICS

LE 70 11 03 Transparent
LE 70 40 03 Multilaser Orange
LE 70 98 03 Hi-Altitude

ACCESSORIES

GOOGLE INTERFACE / SIDE SHIELDS - KIT

Black Matte
AC 56 00 46

Blue Avio / Grey
AC 56 00 46 B



ELASTIC STRAP

Black
AC 56 00 45

Blue Navy
AC 56 00 45 B



IMPACTX®

ELASTIC STRAP AND SHIELD INTERFACE INCLUDED



BLACK MATTE
ImpactX Photochromic 2 Laser Crimson
SP 70 72 06 - 0000

RP OPTICS

ELASTIC STRAP AND SHIELD INTERFACE INCLUDED



BLACK MATTE
Hi-Altitude
+ Multilaser Gold lenses
+ Trasparent lenses
SP 70 98 06 - S003



BLUE NAVY MATTE
Multilaser Orange
SP 70 40 47 - 0000

AGENT Q STEALTH



BLACK MATTE
ImpactX Photochromic 2 Black
SP 70 73 06 - SH00

CERTIFIED Z87.1



BLACK MATTE
Smoke Black
SP 70 10 06 - SH00

CERTIFIED Z87.1

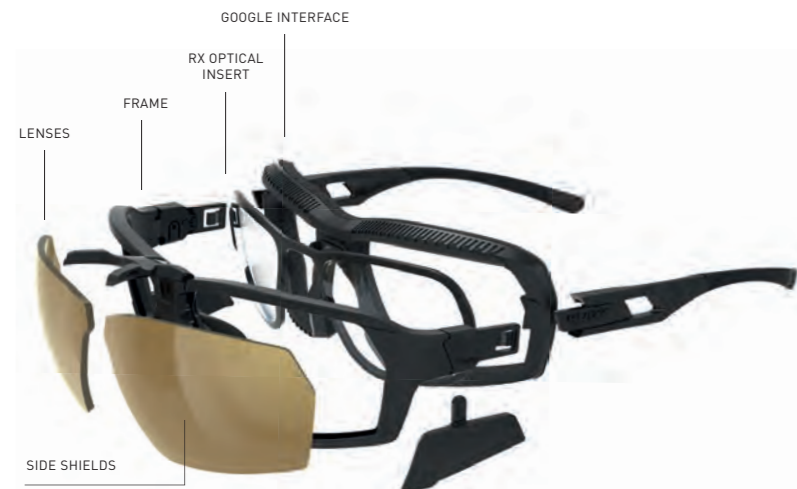

**active
lifestyle**

ACTIVE LIFESTYLE



BASE 6
o: 1,2
g: 31

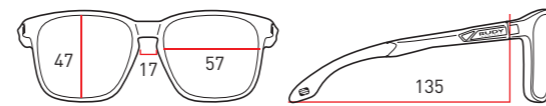

Lightflow A



RILSAN

RP OPTICS



NEW
CRYSTAL BUTTERSCOTCH GLOSS
Laser Green
SP 82 32 83 - 0000



OLIVE MATTE
Laser Green
SP 82 32 13 - 0000



TEAL MATTE
Multilaser Orange
SP 82 40 64 - 0000



CRYSTAL GLOSS
Multilaser Ice
SP 82 68 96 - 0000



ICE BLUE METAL MATTE
Multilaser Red
SP 82 38 53 - 0000

ACCESSORIES

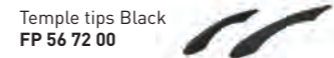

Temple tips Black
FP 56 72 00

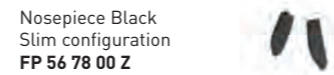

Nosepiece Black
Slim configuration
FP 56 78 00 Z

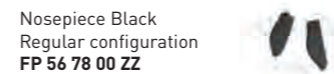

Nosepiece Black
Regular configuration
FP 56 78 00 ZZ

POLAR 3FX / HDR



BLACK MATTE
Polar3FX Grey
SP 82 59 06 - 0000



BASE 6
o: 1,1
g: 29

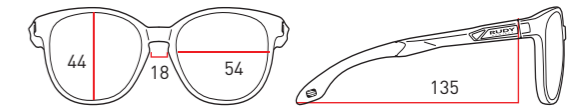

Lightflow B



RILSAN



FOR SMALLER
FACES

RP OPTICS



NEW
CRYSTAL GLOSS
Laser Black
SP 83 09 96 - 0000



GLACIER MATTE
Multilaser Osmium
SP 83 34 59 - 0000



BLUE NAVY
Multilaser Rose
SP 83 67 47 - 0000



ICE GOLD MATTE
Multilaser Gold
SP 83 57 21 - 0000

POLAR 3FX / HDR



BLACK MATTE
Polar3FX Grey
SP 83 59 06 - 0000



BLACK MATTE
Polar3FX HDR Multilaser Red
SP 83 62 06 - 0000

ACCESSORIES



Temple tips Black
FP 56 72 00

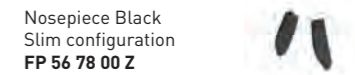

Nosepiece Black
Slim configuration
FP 56 78 00 Z

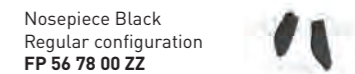

Nosepiece Black
Regular configuration
FP 56 78 00 ZZ



BASE 6
o: 0,75
g: 21

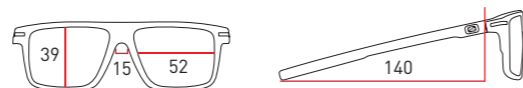

Stellar



RP OPTICS



DEMI BROWN GLOSS
Green
SP 91 01 10 - 0000



WHITE MATTE
Smoke Black
SP 91 10 58 - 0000



CRYSTAL GLOSS
Multilaser Sunset
SP 91 52 96 - 0000



BLACK MATTE
Smoke Black
SP 91 10 06 - 0000



CRYSTAL AZUR
Multilaser Green
SP 91 41 68 - 0000

POLAR 3FX / HDR



BLACK MATTE
Polar 3FX Grey
SP 91 59 06 - 0000



BASE 6
o: 0,88
g: 25

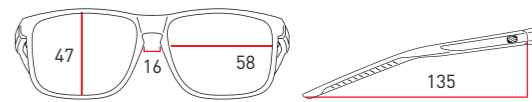

Overlap



RP OPTICS



NEW
CRYSTAL BUTTERSCOTCH GLOSS
Green
SP 77 01 83 - 0000



CRYSTAL GLOSS
Multilaser Sunset
SP 77 52 96 - 0000



ICE BLUE METAL MATTE
Multilaser Red
SP 77 38 53 - 0000



CHARCOAL MATTE
Multilaser Gold
SP 77 57 38 - 0000



BLACK GLOSS
Smoke Black
SP 77 10 42 - 0000

POLAR 3FX / HDR



BLACK MATTE
Polar3FX Grey
SP 77 59 06 - 0000



CRYSTAL ASH
Polar3FX HDR Multilaser Green
SP 77 61 33 - 0000



BASE 6
o: 1,1
g: 32

Spinair 57



ADJUSTABLE
TEMPLE



RP OPTICS



CRYSTAL ASH DEG
Laser Black
SP 57 09 72 - 0000



BLACK GLOSS
Smoke Black
SP 57 10 42 - 0000



FROZEN ASH
Multilaser Orange
SP 57 40 87 - 0000



BLACK FADE BRONZE MATTE
Multilaser Gold
SP 57 57 06 - 0010



CARBONIUM
Multilaser Red
SP 57 38 19 - 0000



CRYSTAL BLUE
Multilaser Blue
SP 57 39 77 - 0000

POLAR 3FX / HDR



CRYSTAL GRAPHITE
Polar 3FX HDR Multilaser Green
SP 57 61 95 - 0000



MATTE BLACK
Polar 3FX Grey
SP 57 59 06 - 0000

ACCESSORIES

Temple tips Black
FP 56 72 00



Nosepiece Black
Slim configuration
FP 56 78 00 Z



Nosepiece Black
Regular configuration
FP 56 78 00 ZZ



**SPINAIR 57 CHROMATIC
FULL CUSTOM KIT**
Includes 1 set of temple tips, 1
asian fit nosepiece, 1 asian fit plus
nosepiece.

Mandarin
AC 21 01 57 Z



Lime
AC 21 01 55 Z



Blue
AC 21 01 56 Z

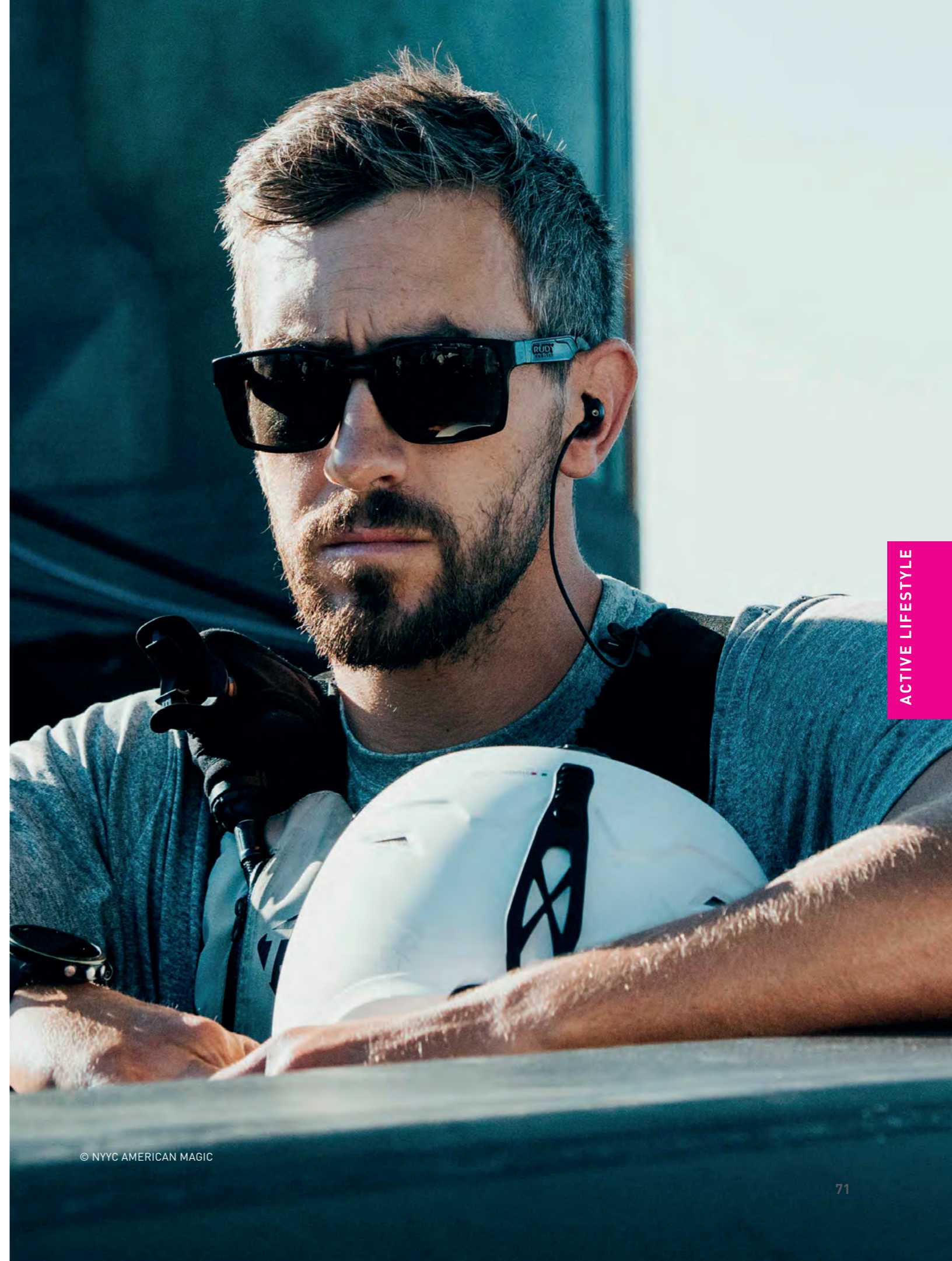

ACTIVE LIFESTYLE



BASE 6
o: 0,74
g: 21

Glamshady NEW



FOR SMALLER
FACES



RP OPTICS



BLACK MATTE
Smoke Black
SP 93 10 06 - 0000



CRYSTAL GLOSS
Multilaser Ice
SP 93 68 96 - 0000



CRYSTAL ASH GLOSS
Multilaser Violet
SP 93 42 33 - 0000



CRYSTAL BUTTERSCOTCH GLOSS
Green
SP 93 01 83 - 0000

POLAR 3FX / HDR



BLACK GLOSS
Polar 3FX HDR Multilaser Red
SP 93 62 42 - 0000



BASE 6
o: 1,12
g: 32

Spinhawk Edge NEW



RP OPTICS



BLACK MATTE
Smoke Black Deg
SP 90 51 06 - 0000



CRYSTAL ASH GLOSS
Multilaser Sunset
SP 90 42 33 - 0000



DEMI BROWN MATTE
Green
SP 90 01 40 - 0000



**CRYSTAL BLUE AVIO /
APPLE GREEN FADE**
Multilaser Yellow
SP 90 05 02 - 0000



**BLACK FADE
CRYSTAL AZUR GLOSS**
Multilaser Ice
SP 90 68 42 - 0000

POLAR 3FX / HDR



BLACK MATTE
Polar 3FX Grey
SP 90 59 06 - 0000



BASE 6
o: 1,30
g: 37

Skytrail

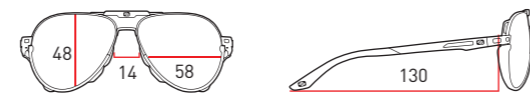

RP OPTICS



ALUMINUM MATTE
Multilaser Ice
ML 38 68 01 - 0001



GUN MATTE
Smoke Black Deg
ML 38 51 02 - 0000



ALUMINUM MATTE
Multilaser Orange
ML 38 40 01 - 0000



ALUMINUM MATTE
Laser Black
ML 38 09 01 - 0000

NO BUMPERS VERSION



BASE 6
o: 0,88
g: 25

Soundrise

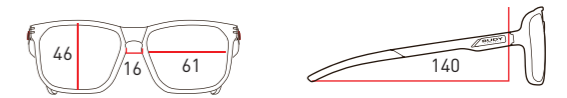

RP OPTICS



CRYSTAL GLOSS
Multilaser Blue
SP 13 39 96 - 0000



BLACK FADE CRYSTAL AZUR GLOSS
Multilaser Ice
SP 13 68 42 - 0011



BLACK GLOSS
Smoke Black
SP 13 10 42 - 0000



BLACK FADE BRONZE MATTE
Multilaser Orange
SP 13 40 06 - 0010



BLACK MATTE / ICE GOLD PATTERN
Multilaser Gold
SP 13 57 06 - 0003

POLAR 3FX / HDR



BLACK MATTE
Polar 3FX HDR Multilaser Red
SP 13 62 06 - 0001



BLACK MATTE
Polar 3FX Grey
SP 13 59 06 - 0002

rx | optical



rx solutions



rx direct

THE ULTIMATE OPTION

- the world's most advanced digital surface lenses
- fully personalised
- Maximum impact resistance
- Stylish wraparound design
- Superior eye comfort (absence of distortions)
- photochromic or polarized lenses



rx inserts

THE VALUE OPTION

- Easy to mount and interchangeable
- Perfect for lower budgets
- Allows opticians to edge prescription lenses in the office
- Available on all performance models
- Perfect for contact lens wearers



rx optical dock

THE HIGH CORRECTION SPORT OPTION

- Easy to mount and interchangeable
- Perfect for sport high prescriptions
- Available in our top selling performance models
- allows opticians to edge prescription lenses in the office
- full rim interchangeable design
- built to last



rx direct clips

THE UTILITY OPTION

- Easy to mount and interchangeable allows opticians to edge prescription lenses in the office
- Perfect for high prescriptions
- Ideal for contact lens wearers who want another option for when eyes become irritated
- High versatility of interchangeable clear and sun RX lenses in the same frame
- Adapts perfectly to different contexts



rx readers

THE INTEGRATED READING OPTION

- Perfect for people with presbyopic correction needs
- Helps to read - maps, smart/mobile devices, hear rate monitors, score cards, etc..
- PC bifocal lenses available in 3 powers and 3 vibrant multilayer colours



rx flip-up

THE VERSATILE OPTION

- Perfect for high prescriptions and versatile sun protection
- Allows instant control over light transmission
- Designed for sport but ideal for any occasion
- Driving friendly
- Allows opticians to edge prescription lenses in the office



rx ophthalmic

THE PRESCRIPTION OPTION

- Inspired from our performance models features but with the casual touch
- Allows opticians to edge prescription lenses in the office

quick optical guide

EYEWEAR	PATENTED QUICK INSERT TECHNOLOGY ON ADAPTER	impactrx RP OPTICS highindex	RX OPTICAL INSERT	RX OPTICAL DOCK	RX DIRECT CLIPS
AGENT Q		■	FR 07 00 00 A 35 / B 49 DBL 23 BASE 5		
ASTRAL			FR 84 00 00 A 42 / B 56 DBL 14 BASE 5		
NEW ASTRAL X			FR 84 00 00 A 42 / B 56 DBL 14 BASE 5		
CUTLINE		ONLY FOR CUTLINE INSET WITH IMPACTRX	FR 39 00 00 A 50 / B 33 DBL 13 BASE 5		
DEFENDER			FR 52 00 00 A 57 / B 37 DBL 13 BASE 6		
DELTABEAT			FR 70 00 00 A 45 / B 33 DBL 20 BASE 6	FR 74 OD 87- A 52 / B 43 DBL 20 BASE 4	
KELION			FR 84 00 00 A 42 / B 56 DBL 14 BASE 5		
MAGNUS		■	FR 70 00 00 A 45 / B 33 DBL 20 BASE 6	FR 53 OD 87- A 52 / B 38 DBL 20 BASE 6	
NEW NYAD		■	FR 87 00 00 A 47 / B 34 DBL 22 BASE 5		
PROPULSE		■	FR 70 00 00 A 45 / B 33 DBL 20 BASE 6		
RYDON		■	FR 70 00 00 A 45 / B 33 DBL 20 BASE 6	FR 79 OD -- A 54 / B 34 DBL 20 BASE 4	FR 80 00 02 A A 60 / B 38 DBL 21 BASE 8
RYDON SLIM		■	FR 70 00 00 A 45 / B 33 DBL 20 BASE 6	FR 54 OD -- A 51 / B 34 DBL 20 BASE 4	
SIRIUS		■	FR 87 00 00 A 47 / B 34 DBL 22 BASE 5	FR 87 OD 06 A 40 / B 35 DBL 21 BASE 6	
SPINSHIELD AIR			FR 84 00 00 A 42 / B 56 DBL 14 BASE 5		
STARDASH			FR 70 00 00 A 45 / B 33 DBL 20 BASE 6		
NEW TURBOLENCE		■	FR 39 00 00 A 50 / B 33 DBL 13 BASE 5		
GOGGLE					
SKERMO			FR 12 00 00 A 54 / B 49 DBL 19 BASE 6		
SPINCUT			FR 12 00 00 A 54 / B 49 DBL 19 BASE 6		



impactrx 2black

☞ 74% - 9% | Cat.1/3



NAKED EYES



ACTIVATED

impactrx 2laserblack

☞ 62% - 13% | Cat.1/3



NAKED EYES



ACTIVATED

impactrx 2red

☞ 76% - 17% | Cat.1/3



NAKED EYES



ACTIVATED

impactrx 2laserpurple

☞ 48% - 8% | Cat.1/3



NAKED EYES

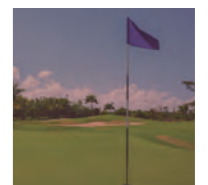

ACTIVATED

Offering freeform single vision and progressive lens design for performance sport wraps, ImpactRX® is the world's most advanced digital back surface lens program, fully personalized for your lifestyle. We've combined a revolutionary lens material with the best wrap design to create the best prescription sports lens in the world! Now available in many superlative platforms. For more information please contact your country official Rudy Project distributor (<http://www.rudyproject.com/customer-service/distributors/>) or send an email to rudyrx@rudyproject.com to receive your personal web credentials. Once activated you can immediately place orders.

WARNING The content of this catalog section is dedicated exclusively to opticians and qualified healthcare operators. Therefore, in compliance with the Italian legislation, I declare under my own responsibility that I am a qualified professional in the optical and/or ophthalmology sector and I am allowed to have access to this content.

**rx direct
impactrx**

RP optics high index

OUR 1.6 ENTRY MATERIAL OF CHOICE FOR PATIENTS WITH HIGH PRESCRIPTIONS, OR WHEN LENS THICKNESS CONSIDERATION IS ESSENTIAL

Rudy Project created a new and innovative Hybrid material, dedicated to patients with stronger prescriptions: the ImpactRx High Index combines the best attributes of High Index, such as its extraordinary thinness, to the comfort of ImpactRX, offering strength and durability.

Main features include:

- LOWER DENSITY TO PROVIDE LIGHTER LENSES AND INCREASED COMFORT
- ENHANCED IMPACT RESISTANCE (UP TO 5 TIMES WHEN COMPARED TO OUR PREVIOUS HI-1.6 MATERIAL)
- IMPROVED COSMETIC FOR WRAP LENSES
- THINNER THAN COMMON HIGH INDEX 1.60 MATERIALS (UP TO 5%)



TECHNICAL FEATURES Density gr/cm3 1,23- Refractive index 1,60 - Abbe Number 41 - UV Cutout 400 - Absorption 100% UVA UVB

TRANSPARENT

☞ 90,7% | Cat.0



ACTION BROWN

☞ 10,7% | Cat.3



MULTILASER ORANGE

☞ 17,4% | Cat.3



RACING RED

☞ 32,9% | Cat.2



SMOKE

☞ 18% | Cat.3



LASER BLACK

☞ 18% | Cat.3



MULTILASER BLUE

☞ 18% | Cat.3



Transitions Signature VII

IMPACTRX® HIGH INDEX TRANSITION GREY

☞ 12% - 92% | Cat.0/3

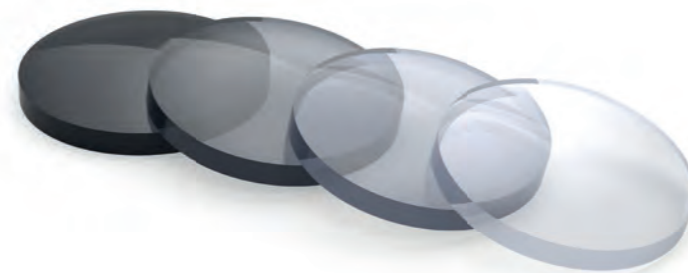

diamond coat



WHAT IS DIAMOND COAT? Diamond Coat is an exceptional and powerful multi-layer coating engineered to eliminate lens glare, ghost images and halos from bright light or back reflections while offering a cleaner vision by preventing dust, water drops, scratches and finger marks on the lens. Perfect for outdoor action and dusty environments, Diamond Coat will keep lenses sparkling and easy to clean. It will ensure a better comfort while providing outstanding lens durability.

The Rudy Project Diamond Coat is a superior treatment resulting from extensive research and provides the following features:

- anti-static layer against dust and impurities
- anti-reflection coating, cutting lens glare, ghosts and halos resulting from bright light
- enhanced protection against finger marks
- superior hydrophobic layers against water drops
- outstanding scratch protection, ensuring lens durability

polar 3FX 1.59

WHAT IS POLAR 3FX?

POLARIZED LENSES effectively block reflected glare, a situation which occurs primarily near water or snow or off reflective surfaces nearby, such as car windows, metallic objects, etc. Light which strikes a horizontal reflective surface is reflected back into your eyes. You then get a "double dose" of light energy, some of which falls directly on to you and some that is reflected on to you. Polarized lenses offer an interesting advantage: because they dramatically reduce or eliminate the reflected light energy which might account for the majority of the annoying glare, you can use a lighter tint to achieve the same (or better) degree of glare reduction and comfort compared to non-polarized dark lenses.

PATENTED 3FX POLARIZED TECHNOLOGY

POLAR3FX coatings offer:

- Advanced visual acuity, depth of field perception, chromatic partitioning.
- Minimizes annoying staining and smudging for clean, unobstructed vision all the time.
- Highly scratch resistant.
- A unique and sophisticated fashionable look.

DIAMOND COAT INCLUDED

Rudy Project's unique multi-layer process provides excellent visual acuity and eliminates annoying back glare that causes eye strain and eye fatigue in bright light conditions. Reduced hue and ambient reflections.

POLAR 3FX [1.59]

TECHNICAL FEATURES Density gr/cm3 1,20- Refractive index 1,59 - Abbe Number 31 - UV Cutout 385 - Absorption 100% UVA UVB



ANTI-REFLECTION COATING

Lenses with higher indices also reflect more than standard plastic and glass. Because of this, anti-reflective coating is especially important. Additional reflections will be distracting in day to day activities such as night driving and computer use. Impurities, water drops, dust, scratches will heavily influence the comfort of high index lenses, for these reasons, Rudy Project offers diamond coat, our new premium coating.

ATTENTION

For its highly engineered vision solution using extremely sophisticated edging equipments, all models of the ImpactRX and ImpactRX High Index collection are mounted and shipped directly and exclusively through our own laboratories according to selected sunwear geometry and original patient's prescription formula.

POLAR 3FX [1.59] HDR

After years of intense research, we have updated our Polar3FX technology to take your vision to the next level. Polar3FX HDR technology eliminates glare providing superior visual comfort, enhanced contrast and contours. In addition, the new Polar3FX lenses incorporate the HDR (high dynamic range) filter to further define contrast and color perception. To ensure maximum toughness and durability, we have boosted the Polar 3FX lenses with the revolutionary 3FX Coating anti smudge and anti aging treatment.

POLAR 3FX HDR MULTILASER BLUE



POLAR 3FX HDR MULTILASER RED



POLAR 3FX HDR MULTILASER ORANGE



POLAR 3FX HDR MULTILASER GREEN



PROGRESSIVE 15 mm.

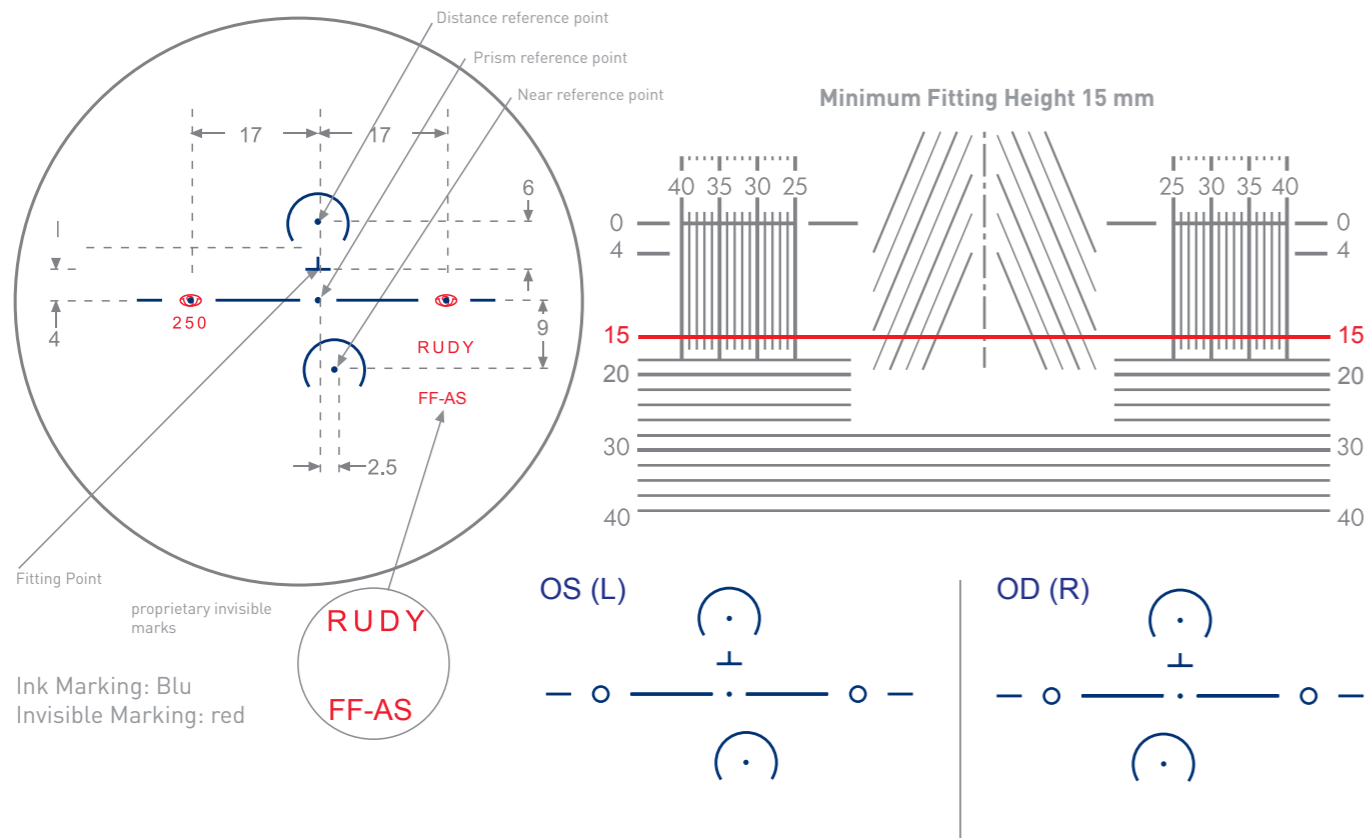

SINGLE VISION

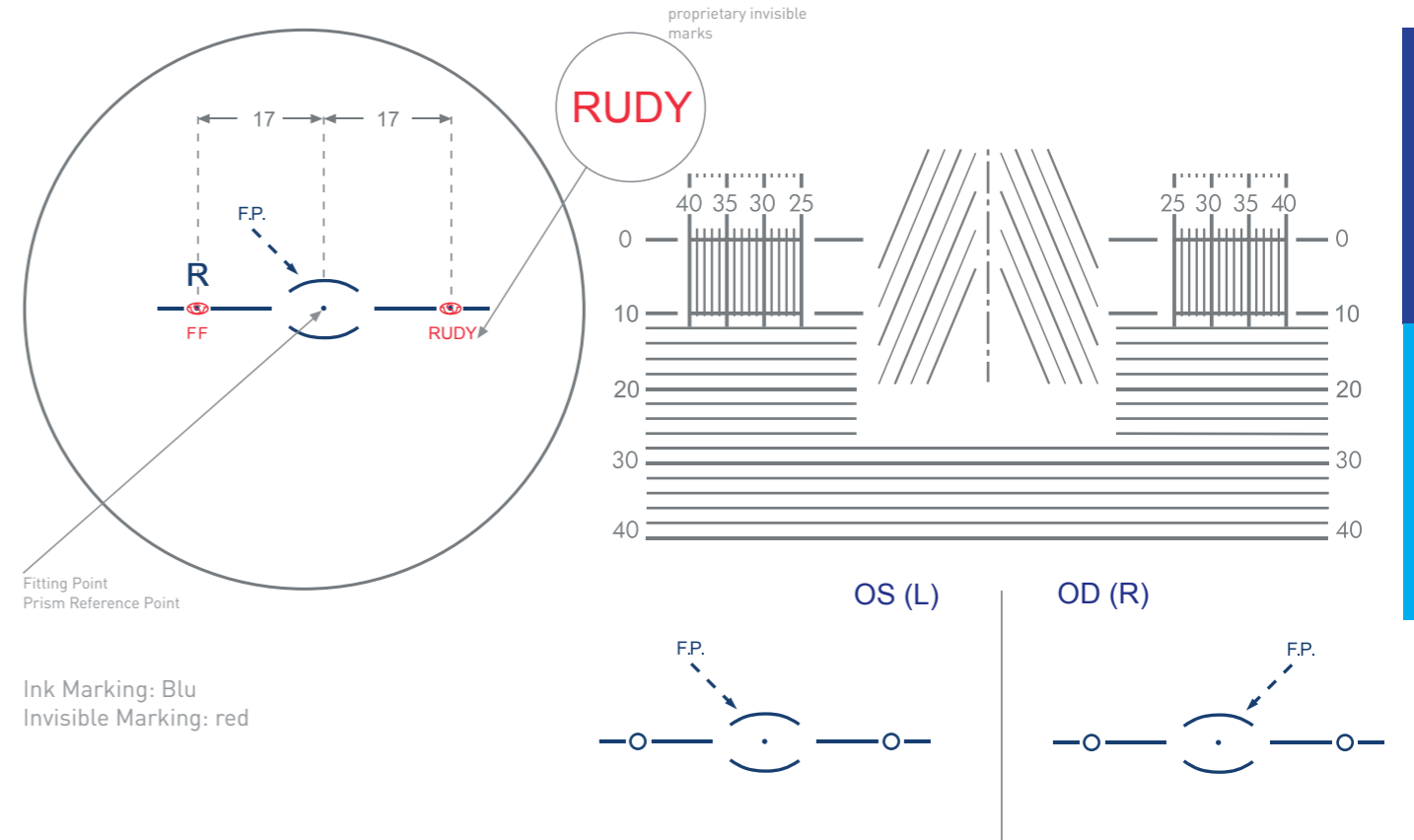

PROGRESSIVE 18 mm.

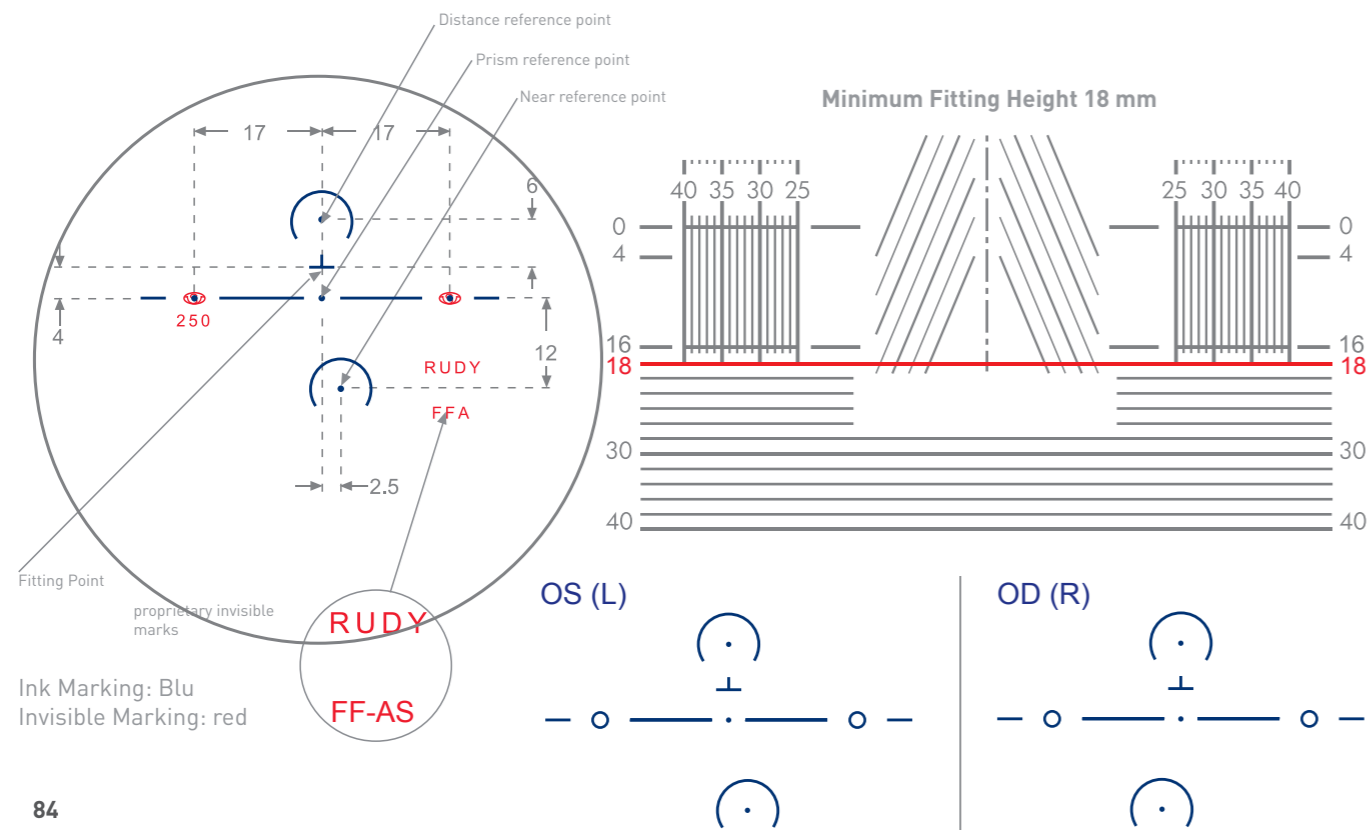

NEW

turbulence

weight ounces: 1,02 grams: 29
 eye size dbl temple 135 — 138 - h 53
 base 7



THE HEIGHT MEASUREMENT MUST BE DETECTED FROM THE LOWER EDGE OF THE PLANO LENS

	58	60	62	64	66	68	70
impactrx Turbulence* 53	-3.00 to +2.50	-3.50 to +2.75	-3.75 to +3.00	-4.00 to +3.75	-4.25 to +3.50	-4.50 to +3.75	-4.50 to +4.00

* AVAILABLE ONLY FOR IMPACTRX PHOTOCROMIC 2 BLACK

NEW

nyad

weight ounces: 1,02 grams: 30
 eye size dbl temple 64 □ 14 — 130 - h 42
 base 8



	58	60	62	64	66	68	70
impactrx Nyad	64 -2,50+2,50	-2,50+2,50	-2,75+2,75	-2,75+2,75	-3,00+2,75	-3,25+3,00	-3,25+3,00
RP OPTICS highindex Nyad	64 -3,00+3,00	-3,25+3,00	-3,50+3,25	-3,50+3,25	-3,75+3,50	-4,00+3,50	-4,25+3,50
POLAR SFX (1.59) Nyad	64 -3,00+3,00	-3,25+3,00	-3,50+3,25	-3,50+3,25	-3,75+3,50	-4,00+3,50	-4,25+3,50
POLAR SFX (1.59) HDR Nyad	64 -3,00+3,00	-3,25+3,00	-3,50+3,25	-3,50+3,25	-3,75+3,50	-4,00+3,50	-4,25+3,50

cutline

weight ounces: 1,27 grams: 36
 eye size dbl temple 139 — 127 - h 62
 base 7



THE HEIGHT MEASUREMENT MUST BE DETECTED FROM THE LOWER EDGE OF THE PLANO LENS

	58	60	62	64	66	68	70
impactrx Cutline*	62 -3.00 to +2.50	-3.50 to +2.75	-3.75 to +3.00	-4.00 to +3.75	-4.25 to +3.50	-4.50 to +3.75	-4.50 to +4.00

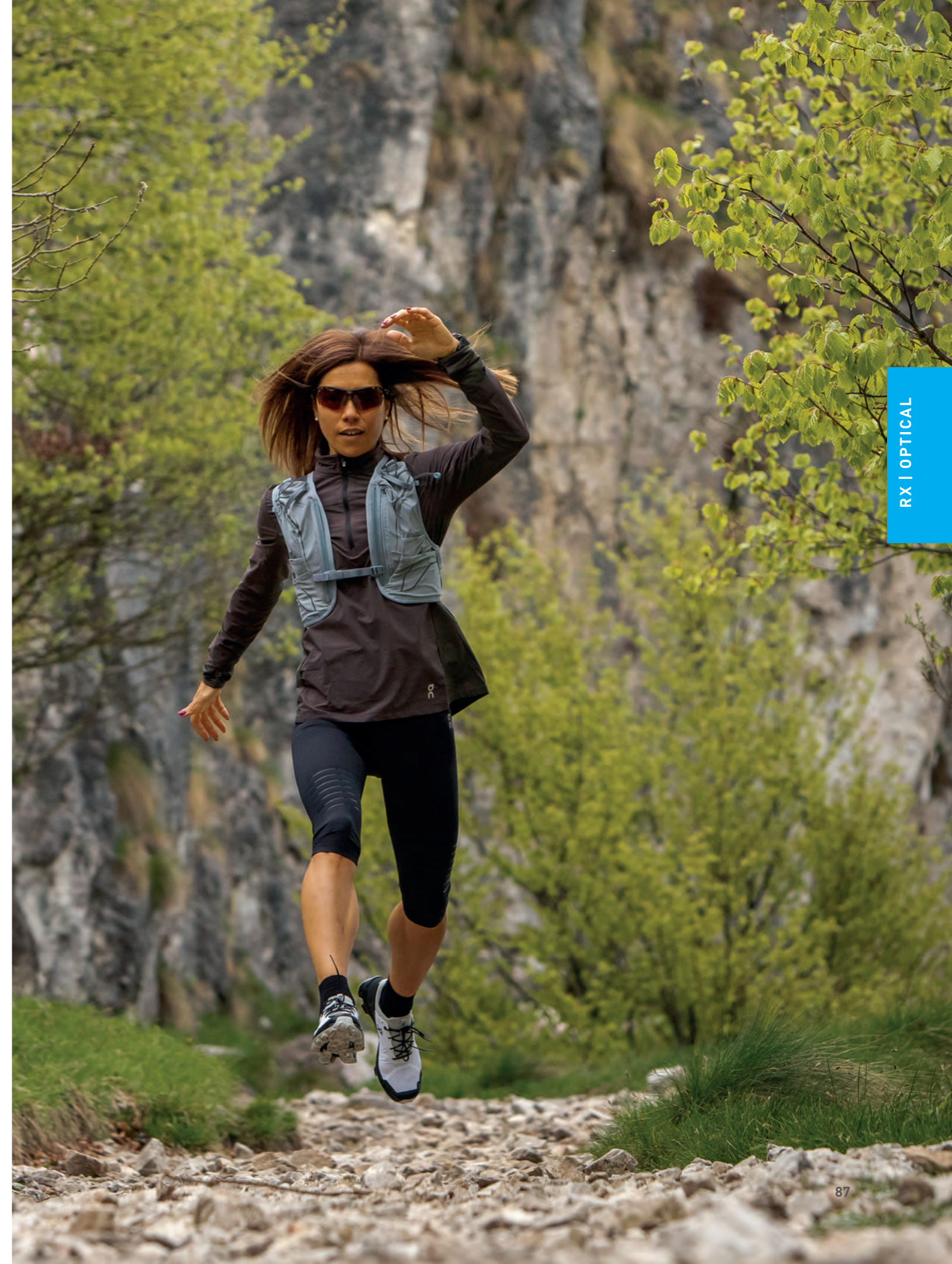

RX | OPTICAL

sirius

weight ounces: 1,1 grams: 30
 eye size dbl temple 50 □ 17 — 130 - h 39
 base 8

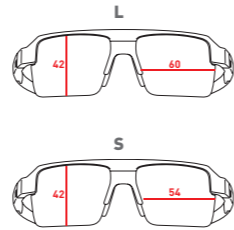

		58	60	62	64	66	68	70
impactrx	Sirius L	60	-3,00+4,50	-3,00+4,75	-3,25+5,25	-3,50+5,50	-3,75+6,00	-3,75+6,75
	Sirius S	54	-3,00+4,75	-3,25+5,00	-3,50+5,25	-3,75+5,75	-4,00+6,25	-4,25+7,25
RP OPTICS highindex	Sirius L	60	-3,50+5,75	-3,75+6,00	-4,00+6,50	-4,25+7,00	-4,50+7,50	-4,50+7,75
	Sirius S	54	-3,50+5,75	-4,00+6,00	-4,25+6,75	-4,50+7,00	-4,75+7,50	-5,00+8,25
POLAR 3FX (1.59)	Sirius L	60	-3,00+2,75	-2,25+3,00	-3,50+3,25	-3,50+3,50	-3,50+3,75	-3,75+4,00
	Sirius S	54	-3,25+3,00	-3,25+3,00	-3,50+3,50	-3,50+3,75	-3,75+4,00	-4,00+4,25
POLAR 3FX (1.59) HDR	Sirius L	60	-3,00+2,75	-2,25+3,00	-3,50+3,25	-3,50+3,50	-3,50+3,75	-3,75+4,00
	Sirius S	54	-3,25+3,00	-3,25+3,00	-3,50+3,50	-3,50+3,75	-3,75+4,00	-4,00+4,25

agent q

weight ounces: 1,38 grams: 39
 eye size dbl temple 68 □ 17 — 135 - h 43
 base 8

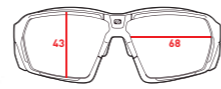

		58	60	62	64	66	68	70
impactrx	Agent Q	68	-2,00+2,00	-2,00+2,00	-2,25+2,25	-2,25+2,25	-2,50+2,25	-2,75+2,50
RP OPTICS highindex	Agent Q	68	-2,50+2,50	-2,75+2,50	-3,00+2,75	-3,00+2,75	-3,25+2,75	-3,50+3,00
	Agent Q	68	-2,50+2,50	-2,75+2,50	-3,00+2,75	-3,00+2,75	-3,25+2,75	-3,50+3,00
POLAR 3FX (1.59) HDR	Agent Q	68	-2,50+2,50	-2,75+2,50	-3,00+2,75	-3,00+2,75	-3,25+2,75	-3,50+3,00

magnus

weight ounces: 1,02 grams: 29
 eye size dbl temple 75 □ 11 — 133 - h 45
 base 8

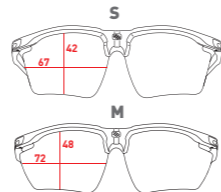

		58	60	62	64	66	68	70
impactrx	Magnus	75	-1,50+1,50	-1,75+1,50	-2,00+1,75	-2,00+1,75	-2,25+1,75	-2,50+2,00
RP OPTICS highindex	Magnus	75	-1,50+1,25	-1,50+1,25	-1,50+1,50	-1,50+1,50	-1,75+1,50	-2,25+1,50
	Magnus	75	-1,50+1,50	-1,75+1,50	-2,00+1,75	-2,00+1,75	-2,25+1,75	-2,50+2,00
POLAR 3FX (1.59) HDR	Magnus	75	-1,50+1,50	-1,75+1,50	-2,00+1,75	-2,00+1,75	-2,25+1,75	-2,50+2,00

rydon

weight ounces: 0,88 grams: 24
 eye size dbl temple 71 □ 12 — 133
 base 8

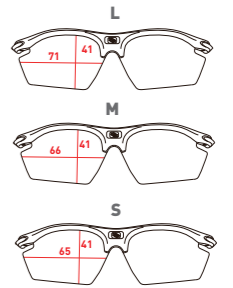

		58	60	62	64	66	68	70
impactrx	Rydon L	71	-2,00+1,75	-2,25+2,00	-2,50+2,25	-2,75+2,25	-3,00+2,50	-3,00+2,75
	Rydon M	66	-2,75+2,50	-3,00+2,75	-3,00+3,00	-3,25+3,00	-3,50+3,25	-3,75+3,50
	Rydon S	64	-3,50+2,75	-3,50+3,00	-3,50+3,25	-3,75+3,50	-3,75+3,75	-4,00+4,00
RP OPTICS highindex	Rydon L	71	-2,25+2,00	-2,50+2,25	-2,75+2,50	-3,00+2,75	-3,25+3,00	-3,50+3,00
	Rydon M	66	-2,75+2,75	-3,00+3,00	-3,25+3,00	-3,50+3,25	-3,75+3,50	-4,25+3,50
	Rydon S	64	-3,50+3,25	-3,50+3,50	-4,00+3,75	-4,25+3,75	-4,50+4,00	-5,00+4,00
POLAR 3FX (1.59) HDR	Rydon L	71	-2,50+2,00	-2,75+2,25	-3,00+2,50	-3,25+2,75	-3,50+3,00	-3,75+3,00
	Rydon M	66	-3,25+2,75	-3,50+3,00	-3,75+3,00	-4,00+3,25	-4,25+3,50	-4,75+3,50
	Rydon S	64	-3,50+3,50	-3,75+3,50	-4,25+3,75	-4,50+3,75	-4,75+4,00	-5,25+4,00

rydon slim

weight ounces: 0,88 grams: 24
 eye size dbl temple 66 □ 12 — 133 - h 40
 base 8



		58	60	62	64	66	68	70
impactrx	Rydon Slim	66	-3,50+2,75	-3,50+3,00	-3,50+3,25	-3,75+3,50	-3,75+3,75	-4,50+4,00
RP OPTICS highindex	Rydon Slim	66	-3,25+3,50	-3,50+3,50	-4,00+3,75	-4,25+3,75	-4,50+4,00	-5,25+4,00
	Rydon Slim	66	-3,50+3,50	-3,75+3,50	-4,25+3,75	-4,50+3,75	-4,75+4,00	-5,25+4,00
POLAR 3FX (1.59) HDR	Rydon Slim	66	-3,50+3,50	-3,75+3,50	-4,25+3,75	-4,50+3,75	-4,75+4,00	-5,25+4,00

propulse

weight ounces: 0,9 grams: 26
 eye size dbl temple 72 □ 11 — 126
 base 8

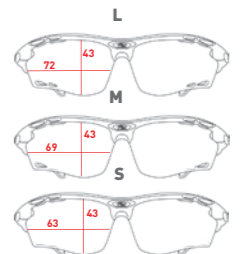

		58	60	62	64	66	68	70
impactrx	Propulse L	72	-1,50+1,25	-1,50+1,25	-1,50+1,50	-1,50+1,50	-1,75+1,50	-2,25+1,50
	Propulse M	69	-2,00+1,75	-2,00+1,75	-2,25+2,25	-2,25+2,25	-2,50+2,25	-2,75+2,25
	Propulse S	63	-2,00+2,25	-2,00+2,25	-2,50+2,25	-2,50+2,25	-2,75+2,25	-3,00+2,50
RP OPTICS highindex	Propulse L	72	-1,50+1,50	-1,75+1,50	-2,00+1,75	-2,00+1,75	-2,25+1,75	-2,50+2,00
	Propulse M	69	-2,50+2,00	-2,75+2,50	-3,00+2,25	-3,00+2,25	-3,25+2,50	-3,50+2,50
	Propulse S	63	-2,50+2,50	-2,75+2,50	-3,00+2,25	-3,25+2,75	-3,50+2,75	-3,75+3,00
POLAR 3FX (1.59) HDR	Propulse L	72	-1,50+1,50	-1,75+1,50	-2,00+1,75	-2,00+1,75	-2,25+1,75	-2,50+2,00
	Propulse M	69	-2,50+2,00	-2,75+2,50	-3,00+2,25	-3,00+2,25	-3,25+2,50	-3,50+2,50
	Propulse S	63	-2,50+2,50	-2,75+2,50	-3,00+2,75	-3,25+2,75	-3,50+2,75	-3,75+3,00



rx optical inserts

Rudy Project has developed RX inserts that can be easily attached behind the polycarbonate lenses. Our 'easy-in easy-out' system allows for effortless insertion and removal of Clip-ons, making them convenient when you want to wear contact lenses or clean your glasses.

1. If the template is unavailable, use the demo (or plano lens) as a reference for cutting the ophthalmic lenses.
2. Properly shape the clip according to the glasses model before installation. After setting it, determine the fit parameters (PD and H) and make final adjustments when mounting progressive lenses.
3. Be sure to note your references for the true horizontal axis before removing the clip to fit ophthalmic lenses.
4. Keep in mind that the vertex distance is reduced when using an Optical RX insert, and this should be considered before mounting ophthalmic lenses.
5. The winding angle of the RX Optical Insert may vary based on the eyewear's design and geometry. It is usually much higher than that of regular dress eyewear, leading to horizontal prismatic deviation, which increases with lens power. Rudy Project generally recommends applying a horizontal shift of +1.00 mm per eye for negative correction and -1.00 mm per eye for positive correction.
6. For spherical lens values greater than +/- 3:00 diopters and considering the high wrap of Rudy Project frames, make necessary adjustments to accommodate the required horizontal prismatic compensation and reduced vertex distance.
7. Always verify the lens centering on the clip when it's inside the frame before mounting ophthalmic lenses. Avoid mounting prescriptions on clips without a frame.
8. To achieve the best results when mounting lenses on the clip, Rudy Project recommends referring to the patient's regular dress eyewear. This will ensure a quicker and easier adaptation to the new device.
9. Rudy Project advises using ophthalmic lenses with spherical geometry. For optimal performance, consider mounting lenses specifically designed for wraparound frames.

-  **FR 84 00 00**
-  **FR 07 00 00**
-  **FR 39 00 00**
-  **FR 87 00 00**
-  **FR 52 00 00**
-  **FR 70 00 00**
-  **FR 12 00 00**

The FR70 RX Optical Insert comes now standard with 3 pairs of proprietary shock absorber stickers; made out of a special polymer they will minimize scratches and vibrations resulting from the insert/correction lenses against the inner surface of the sun/plano lenses. To be mounted on the far edge of each prescription lens of the insert.



OPTICAL CLIP SHOCK ABSORBER KIT (INCLUDED)
6 pcs.
AC 56 00 33 B



KELION WITH FR 84 00 00

rx optical dock

- EXCEPTIONAL FUNCTIONALITY
- OPTIMAL VALUE
- STREAMLINED STYLE

Following years of meticulous research, we've revamped our Optical Dock, one of Rudy Project's most versatile and sought-after sports eyewear solutions, to offer prescription wearers an even more seamless and sophisticated option. The full-rim optical interface boasts a sleek design and broader shape, skillfully blending style with the remarkable adaptability and user-friendliness of the Optical Dock platform. Furthermore, it extends the prescription range for higher correction levels. The Optical Dock 2 is an effortlessly RX-adaptable 6-Base full-rim clip crafted from a sturdy yet flexible polymer, compatible with any lens material, including entry-level edging processes. Its innovative shape provides an expanded field of view and accommodates a wider variety of prescriptions (both standard and progressive), enabling the correction of vision for higher and more intricate levels in a sleek and integrated package. Featuring interchangeable clips, the Optical Dock 2 is simple to install, courtesy of a proprietary screwless system, and is fully compatible with our award-winning 'Rydon' model. This cutting-edge solution is ideal for patients requiring significant vision correction who also desire the design, technology, and comfort of Rudy Project sunglasses. It provides opticians with increased flexibility in handling, while offering cost-effective solutions to customers.

Rydon



PACIFIC BLUE MATTE
Optical Dock Frozen Ash
SP 53 OD 49 - 0000

MATTE BLACK
Optical Dock Frozen Ash
SP 53 OD 06 - 0000

NEW



Optical Dock 2 Frozen Ash
SP 53 OD 06 - 0001



ONLY FRAME
FP 53 00 49 - 0000

ONLY FRAME
FP 53 00 06 - 0000

Rydon Slim



WHITE GLOSS
Optical Dock Frozen Ash
SP 54 OD 69 - 0000

MATTE BLACK
Optical Dock Frozen Ash
SP 54 OD 06 - 0000

NEW



ONLY FRAME
FP 54 00 69 - 0000

ONLY FRAME
FP 54 00 06 - 0000

ONLY OPTICAL DOCK 2

A 52 B 38 DBL 22 - BASE 6

FR 53 OD 87 Frozen Ash



ONLY OPTICAL DOCK

A 54 B 34 DBL 20 - BASE 4

FR 79 OD 58 White Matte

FR 79 OD 87 Frozen Ash

FR 79 OD 27 Lime Matte

FR 79 OD 13 Red Fluo Matte



Sirius



WHITE GLOSS
Optical Dock Frozen Ash
SP 87 OD 69 - 0000

MATTE BLACK
Optical Dock Frozen Ash
SP 87 OD 06 - 0001

NEW



ONLY FRAME
FP 87 00 69 - 0000

ONLY FRAME
FP 87 00 06 - 0001

Magnus



MATTE BLACK
Optical Dock 2 Frozen Ash
SP 75 OD 06 - 0000



ONLY FRAME
FP 75 00 06 - 0000

ONLY OPTICAL DOCK

A 40 B 35 DBL 21 - BASE 6

FR 87 OD 06 Black Matte



ONLY OPTICAL DOCK 2

A 52 B 38 DBL 22 - BASE 6

FR 53 OD 87 Frozen Ash



Deltabeat



WHITE GLOSS
Optical Dock Frozen Ash
SP 74 OD 69 - 0000

MATTE BLACK
Optical Dock Frozen Ash
SP 74 OD 06 - 0000

NEW



ONLY FRAME
FP 74 00 69 - 0000

ONLY FRAME
FP 74 00 06 - 0000

ONLY OPTICAL DOCK

A 52 B 43 DBL 18 - BASE 4

FR 74 OD 87 Frozen Ash

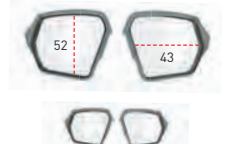



WE ARE THRILLED TO ANNOUNCE THE LATEST ADDITION TO THE RUDY PROJECT FAMILY: OUR INNOVATIVE "DIRECT CLIPS" LINE, DESIGNED SPECIFICALLY FOR CONTACT LENS WEARERS WHO FACE CHALLENGES DURING SPORTS ACTIVITIES OR THOSE WHO REQUIRE A MORE BUDGET-FRIENDLY ALTERNATIVE TO PRESCRIPTION SPORTS SUN LENSES LIKE IMPACTRX. THE DIRECT CLIPS SYSTEM IS A GAME-CHANGER IN THE WORLD OF EYEWEAR, OFFERING A VERSATILE AND COST-EFFECTIVE SOLUTION TO YOUR CUSTOMERS' VISION NEEDS.

With Rudy Project's RX Direct Clips, you can now provide your customers with the convenience of quickly and effortlessly edging prescription lenses right in your office, eliminating the need for complex cutting machines. Our patented smart mounting system allows for easy removal and attachment, making it a breeze for customers to switch between clear and sun RX lenses in the same frame.

Key features of the Direct Clips line include:

- Ease of use: The smart mounting system allows opticians to easily edge prescription lenses in the office, saving time and resources.
- Versatility: Interchangeable clear and sun RX lenses provide customers with the flexibility to adapt their eyewear to various light conditions and activities.
- Budget-friendly: Direct Clips offer a more affordable alternative for customers who are unable to invest in premium prescription sports sun lenses like ImpactRX.
- Ideal for sensitive eyes: Perfect for contact lens wearers who experience irritation during sports practice or other outdoor activities.

By choosing Rudy Project's Direct Clips for your optical practice, you are not only offering your customers a superior eyewear solution but also enhancing their overall experience. This innovative product is sure to set your business apart from the competition and solidify your reputation as a cutting-edge eyewear provider.

Don't miss out on the opportunity to revolutionize your customers' eyewear experience with the Rudy Project Direct Clips line. For more information or to place an order, please contact our dedicated sales team today.



RYDON
black matte frame

frame + direct clip
SP 53 15 06 - V000

only frame
FP 53 00 06 - 0000

only direct clip (A 60 B 39 DBL 21 BASE 8)
FR 80 00 02 A

rx direct clips



made in italy

o: 0,95
g: 27

Inkas - Inkas XL



FLIP-UP



INKAS
Laser Black
FR 68 89 09



INKAS
Smoke
FR 68 89 10



INKAS
Multilaser Ice
FR 68 89 68

INKAS XL
Laser Black
FR 69 89 09

INKAS XL
Smoke
FR 69 89 10

INKAS XL
Multilaser Ice
FR 69 89 68



FLIP-UP

FRAME

CLIPS

ACCESSORIES

REPLACEMENT NOSEPADS

Black
FP 68 77 00



Blue Navy
FP 68 77 30



REPLACEMENT TIPS

Black
FP 68 72 00



Blue Navy
FP 68 72 30



INKAS

INKAS XL

FRAMES

HALF RIM - SHAPE A



INKAS
BLACK MATTE
SP 68 0A 06 - 0000



INKAS
BLUE NAVY MATTE
SP 68 0A 47 - 0000



INKAS
DEMI TURTLE GLOSS
SP 68 0A 50 - 0000

INKAS XL
BLACK MATTE
SP 69 0A 06 - 0000

INKAS XL
BLUE NAVY MATTE
SP 69 0A 47 - 0000

INKAS XL
DEMI TURTLE GLOSS
SP 69 0A 50 - 0000

HALF RIM - SHAPE B



INKAS XL
BLACK MATTE
SP 69 0B 06 - 0000



INKAS XL
BLUE NAVY MATTE
SP 69 0B 47 - 0000



INKAS XL
DEMI TURTLE GLOSS
SP 69 0B 50 - 0000

INKAS CLIPS

FULL RIM



CLIP SIZE 49 | 40 mm

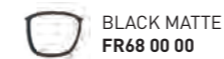

BLACK MATTE
FR68 00 00

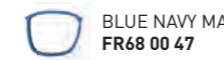

BLUE NAVY MATTE
FR68 00 47

SHAPE A



CLIP SIZE 50 | 41 mm



LIGHT GUN
FR68 00 02 A

SHAPE B



CLIP SIZE 50 | 41 mm



LIGHT GUN
FR68 00 02 B

INKAS XL CLIPS

FULL RIM



CLIP SIZE 51 | 44 mm

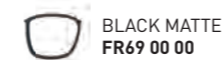

BLACK MATTE
FR69 00 00

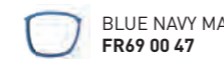

BLUE NAVY MATTE
FR69 00 47

SHAPE A

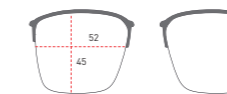

CLIP SIZE 52 | 45 mm



LIGHT GUN
FR69 00 02 A

SHAPE B



CLIP SIZE 52 | 45 mm



LIGHT GUN
FR69 00 02 B



rx readers

Introducing the groundbreaking "Readers" eyewear line from Rudy Project, specifically designed for athletes who see well from a distance but struggle up close when reading bike computers, watches, or newspapers. The all-new RX Readers sunglasses are crafted for sports enthusiasts who require minor vision adjustments without sacrificing style or functionality.

These sport reader prescription lenses are seamlessly integrated into the lower part of the RP Optics sun lens, making it easy for you to read maps or view screens on devices like mobile phones, GPS systems, cycle-computers, and heart rate monitors. The RX Readers offer three configurations of prescription lenses: Smoke, Multilaser Ice, and Multilaser Red. Each of these lenses enhances glare protection while also elevating your aesthetic appearance.

Choose from three different correction powers for each lens color: +1.5, +2.0, and +2.5. With the Rudy Project "Readers" sunglasses, you can confidently and comfortably tackle your favorite sports activities, knowing that you have the perfect combination of style, functionality, and vision support.

RYDON READERS

	CORRECTION POWER +1.50 BLACK MATTE Smoke Black SP 53 B 10 NA 06 - 1500	CORRECTION POWER + 2.00 BLACK MATTE Smoke Black SP 53 B 10 NA 06 - 2000	CORRECTION POWER +2.50 BLACK MATTE Smoke Black SP 53 B 10 NA 06 - 2500
	CORRECTION POWER +1.50 BLACK MATTE Multilaser Ice SP 53 B 68 NA 06 - 1500	CORRECTION POWER + 2.00 BLACK MATTE Multilaser Ice SP 53 B 68 NA 06 - 2000	CORRECTION POWER +2.50 BLACK MATTE Multilaser Ice SP 53 B 68 NA 06 - 2500
	CORRECTION POWER +1.50 BLACK MATTE Multilaser Red SP 53 B 38 NA 06 - 1500	CORRECTION POWER + 2.00 BLACK MATTE Multilaser Red SP 53 B 38 NA 06 - 2000	CORRECTION POWER +2.50 BLACK MATTE Multilaser Red SP 53 B 38 NA 06 - 2500

PROPULSE READERS

	CORRECTION POWER +1.50 BLACK MATTE Smoke Black SP 62 B 10 NA 06 - 1500	CORRECTION POWER + 2.00 BLACK MATTE Smoke Black SP 62 B 10 NA 06 - 2000	CORRECTION POWER +2.50 BLACK MATTE Smoke Black SP 62 B 10 NA 06 - 2500
	CORRECTION POWER +1.50 BLACK MATTE Multilaser Ice SP 62 B 68 NA 06 - 1500	CORRECTION POWER + 2.00 BLACK MATTE Multilaser Ice SP 62 B 68 NA 06 - 2000	CORRECTION POWER +2.50 BLACK MATTE Multilaser Ice SP 62 B 68 NA 06 - 2500
	CORRECTION POWER +1.50 BLACK MATTE Multilaser Red SP 62 B 38 NA 06 - 1500	CORRECTION POWER + 2.00 BLACK MATTE Multilaser Red SP 62 B 38 NA 06 - 2000	CORRECTION POWER +2.50 BLACK MATTE Multilaser Red SP 62 B 38 NA 06 - 2500

WARNING The content of this catalog section is dedicated exclusively to opticians and qualified healthcare operators. Therefore, in compliance with the Italian legislation, I declare under my own responsibility that I am a qualified professional in the optical and/or ophthalmology sector and I am allowed to have access to this content.



rx
flip-up

INTRODUCING RUDY PROJECT'S INNOVATIVE "FLIP-UP" EYEWEAR LINE, SPECIFICALLY DESIGNED FOR ATHLETES AND SPORTS ENTHUSIASTS WHO REQUIRE PRESCRIPTION GLASSES. OUR FLIP-UP GLASSES COMBINE THE VERSATILITY OF PERFORMANCE EYEWEAR WITH THE CONVENIENCE OF A UNIQUE FLIP-UP LENS SYSTEM, ALLOWING YOU TO ADAPT SEAMLESSLY TO SUDDEN CHANGES IN LIGHT CONDITIONS.

Equipped with Quick Change Interchangeable Lens Technology, our Flip-up glasses empower players and athletes to effortlessly manage varying light conditions on the field, on the bike, or on the green. This advanced lens system is perfect for sports where quick visual adjustments are crucial, such as baseball, biathlon, golf, shooting, and archery.

Our revolutionary flip-up mechanism allows you to swiftly lift the additional lenses in case of a sudden decrease in light or remove them entirely to maintain only the prescription glasses. This adaptability helps eliminate fogging and ensures optimal visual clarity for a winning performance.

The Rx insert is designed to accommodate a wide variety of prescriptions, offering eyeglass wearers a sleek and stylish alternative to bulky prescription sports eyewear. Experience the perfect fusion of function and fashion with Rudy Project's Flip-up eyewear line, and elevate your game to new heights.





made in italy

o: 1,3
g: 36

Inkas Flip-Up

Inkas XL Flip-Up

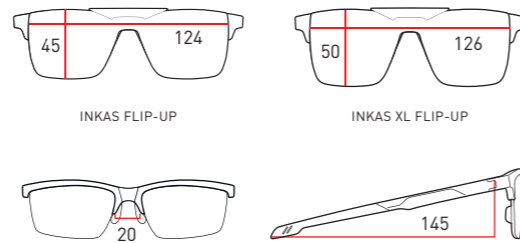

FLIP-UP



INKAS
Laser Black
FR 68 89 09



INKAS
Smoke
FR 68 89 10



INKAS
Multilaser Ice
FR 68 89 68

INKAS XL
Laser Black
FR 69 89 09

INKAS XL
Smoke
FR 69 89 10

INKAS XL
Multilaser Ice
FR 69 89 68

ACCESSORIES

REPLACEMENT NOSEPADS

Black
FP 68 77 00



Blue Navy
FP 68 77 30



REPLACEMENT TIPS

Black
FP 68 72 00



Blue Navy
FP 68 72 30



INKAS HALF RIM - SHAPE A

FRAMES

HALF RIM - SHAPE A



INKAS
BLUE NAVY MATTE
SP 68 68 47 - 0A00



INKAS
DEMI TURTLE GLOSS
SP 68 10 50 - 0A00

INKAS XL
BLUE NAVY MATTE
SP 69 68 47 - 0A00

INKAS XL
DEMI TURTLE GLOSS
SP 69 10 50 - 0A00

FULL RIM



INKAS
DEMI TURTLE GLOSS
SP 68 10 50 - 0000

HALF RIM - SHAPE B



INKAS
BLACK MATTE
SP 68 09 06 - 0B00



INKAS
BLUE NAVY MATTE
SP 68 68 47 - 0B00



INKAS
DEMI TURTLE GLOSS
SP 68 10 50 - 0B00

INKAS XL
BLACK MATTE
SP 69 09 06 - 0B00

INKAS XL
BLUE NAVY MATTE
SP 69 68 47 - 0B00

INKAS XL
DEMI TURTLE GLOSS
SP 69 10 50 - 0B00

INKAS CLIPS

FULL RIM



CLIP SIZE 49 | 40 mm



BLACK MATTE
FR68 00 00

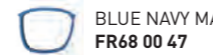

BLUE NAVY MATTE
FR68 00 47

SHAPE A



CLIP SIZE 50 | 41 mm



LIGHT GUN
FR68 00 02 A

SHAPE B



CLIP SIZE 50 | 41 mm



LIGHT GUN
FR68 00 02 B

INKAS XL CLIPS

FULL RIM



CLIP SIZE 51 | 44 mm



BLACK MATTE
FR69 00 00



BLUE NAVY MATTE
FR69 00 47

SHAPE A



CLIP SIZE 52 | 45 mm



LIGHT GUN
FR69 00 02 A

SHAPE B



CLIP SIZE 52 | 45 mm



LIGHT GUN
FR69 00 02 B



rx
ophthalmic

UNLEASH YOUR SPORTY SPIRIT IN EVERYDAY EYEWEAR

INTRODUCING THE OPHTHALMIC LINE, A UNIQUE COLLECTION OF EYEGLASSES DESIGNED FOR THOSE WHO CRAVE A SPORTY LOOK IN THEIR EVERYDAY PRESCRIPTION EYEWEAR. BLENDING ADVANCED SPORTS TECHNOLOGY WITH A LIFESTYLE-ORIENTED DESIGN, OPHTHALMIC GLASSES ARE PERFECT FOR INDIVIDUALS SEEKING TO EXPRESS THEIR ATHLETIC SIDE WHILE ADDRESSING THEIR VISION NEEDS.

Key Features:

- **Sport-Inspired Design:** Drawing from our expertise in high-performance sports eyewear, the Ophthalmic line offers a dynamic, athletic appearance that suits the needs of those requiring prescription lenses for daily use.
- **360-Degree Adjustable Temples:** Experience maximum comfort and stability with our innovative adjustable temple design. Ophthalmic glasses allow for a full 360-degree temple adjustment, ensuring a customized, secure fit for any head shape.
- **Rubber Nose Pads:** To enhance grip and provide a comfortable, secure fit throughout the day, Ophthalmic glasses feature slip-resistant rubber nose pads. These pads prevent the glasses from sliding down the nose, even during intense activities.
- **Versatile Lifestyle Appeal:** While Ophthalmic glasses boast sports-inspired features, they maintain a lifestyle-oriented look that seamlessly transitions from work to play. These stylish frames are perfect for any daily activity, allowing you to embrace your sporty side without compromising on style.

Discover the Ophthalmic line by Rudy Project and experience the perfect fusion of sports functionality and everyday fashion. With Ophthalmic eyewear, you no longer have to choose between performance and style. Embrace your sporty spirit while addressing your vision needs with these exceptional glasses.

Unleash your athletic spirit with Ophthalmic by Rudy Project—where style and performance come together.





BASE 6
o: 1,2
g: 31

Lightflow A

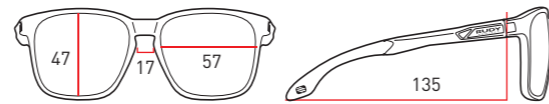

ACCESSORIES



NEW

**CRYSTAL GLOSS /
TEMPLES IN BLACK GLOSS**
Demo Lens
SP 82 0A 96 - 0003



NEW

CRYSTAL AVIO GLOSS
Demo Lens
SP 82 0A 02 - 0000



BLACK MATTE
Demo Lens
SP 82 0A 06 - 0001



CRYSTAL ASH
Demo Lens
SP 82 0A 33 - 0001

Temple tips Black
FP 56 72 00

Nosepiece Black
Slim configuration
FP 56 78 00 Z

Nosepiece Black
Regular configuration
FP 56 78 00 ZZ



BASE 6
o: 1,1
g: 29

Lightflow B

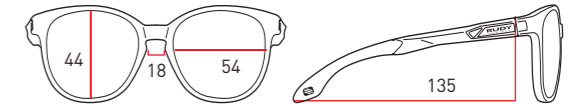

ACCESSORIES



NEW

**CRYSTAL BLUE AVIO /
LILAC FADE GLOSS**
Demo Lens
SP 83 0B 02 - 0001



NEW

ICE GOLD MATTE
Demo Lens
SP 83 0B 21 - 0000



BLACK MATTE
Demo Lens
SP 83 0B 06 - 0000



ICE BLUE METAL MATTE
Demo Lens
SP 83 0B 53 - 0000

Temple tips Black
FP 56 72 00

Nosepiece Black
Slim configuration
FP 56 78 00 Z

Nosepiece Black
Regular configuration
FP 56 78 00 ZZ





made in Italy

BASE 6
o: 0,92
g: 26
(demo lens)



Pulse 53



ACCESSORIES



NEW
CRYSTAL GLOSS
Demo lens
SP 80 0A 96 - 0000



BLACK MATTE
Demo lens
SP 80 0A 06 - 0000



BLACK GLOSS
Demo lens
SP 80 0A 42 - 0000



ICE BLUE METAL MATTE
Demo lens
SP 80 0A 53 - 0000



made in Italy

BASE 6
o: 0,99
g: 28
(demo lens)



Pulse 54



ACCESSORIES



NEW
CRYSTAL OLIVE GLOSS
Demo lens
SP 86 0B 84 - 0000



BLACK MATTE
Demo lens
SP 86 0B 06 - 0000



BLACK GLOSS
Demo lens
SP 86 0B 42 - 0000



ICE BLUE METAL MATTE
Demo lens
SP 86 0B 53 - 0000





made in italy

o: 0,78
g: 22
(demo lens)



Iridis 65



ADJUSTABLE
TEMPLE



ACCESSORIES



NEW

**CRYSTAL OLIVE /
APPLE GREEN FADE GLOSS**
Demo lens
SP 65 0A 84 - 0000



NEW

**CRYSTAL BURGUNDY /
LILAC FADE GLOSS**
Demo lens
SP 65 0A 03 - 0000



CRYSTAL BROWN DEG
Demo lens
SP 65 0A 29 - 0000



CRYSTAL ASH/BLACK GLOSS
Demo lens
SP 65 0A 33 - 0000



CRYSTAL ASH DEG
Demo lens
SP 65 0A 38 - 0000



made in italy

o: 0,81
g: 23
(demo lens)



Iridis 66



ADJUSTABLE
TEMPLE



ACCESSORIES



NEW

CRYSTAL BLUE AVIO GLOSS
Demo lens
SP 66 0A 02 - 0000



NEW

CRYSTAL APRICOT GLOSS
Demo lens
SP 66 0A 26 - 0000



CRYSTAL ASH
Demo lens
SP 66 0A 33 - 0000



DEMI TURTLE GLOSS
Demo lens
SP 66 0A 50 - 0000



BLACK GLOSS
Demo lens
SP 66 0A 42 - 0000





BASE 6
o: 0,75
g: 21

Stellar NEW



RILSAN

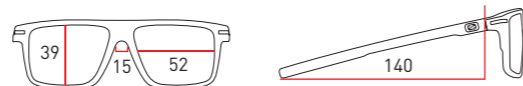

BLACK MATTE
Demo lens
SP 91 0A 06 - 0000



**CRYSTAL BLUE AVIO /
SKY FADE GLOSS**
Demo lens
SP 91 0A 02 - 0000



CRYSTAL OLIVE GLOSS
Demo lens
SP 91 0A 84 - 0000



FROZEN ASH MATTE
Demo lens
SP 91 0A 87 - 0000



**CRYSTAL GLOSS /
INNER COMPUTER PRINTING**
Demo lens
SP 91 0A 96 - 0001



BASE 6
o: 0,74
g: 21

Glamshady NEW



FOR SMALLER
FACES



BLACK MATTE
Demo lens
SP 93 0A 06 - 0000



DEMI BROWN GLOSS
Demo lens
SP 93 0A 10 - 0000



FROZEN ASH MATTE
Demo lens
SP 93 0A 87 - 0000



**CRYSTAL BLUE AVIO /
LILAC FADE GLOSS**
Demo lens
SP 93 0A 02 - 0000



CRYSTAL BUTTERSCOTCH GLOSS
Demo lens
SP 93 0A 83 - 0000

bike helmets



3K CARBON | REINFORCEMENT STRUCTURE

3K Carbon™ technology, designed with a multi-layer composite structure to provide superior protection and performance. The outermost layer is crafted from 3K carbon fiber, known for its exceptional strength-to-weight ratio and impact resistance. Beneath this, a layer of Kevlar adds an extra level of durability and toughness. The inner structure is reinforced with three layers of fiberglass, offering excellent rigidity and energy absorption. This combination of materials ensures that the helmet delivers unparalleled safety.



DUAL DENSITY | EPS CORE

All our helmets use state-of-the-art EPS co-molding technology for enhanced safety, quality and lightweight performance. Loaded with double density EPS core using an innovative internal structure engineered to enhance air circulation and shock absorption capacity, the EGOS is our penultimate development in helmet safety.



RSR MICRO 11 | RETENTION SYSTEM

The all-new miniaturized RSR11 retention system is a sturdy yet extremely lightweight and compact safety frame anchored in the helmet: implemented with vertical fitting options and a handy easy-adjust ratchet wheel to provide a swift and exceptional user-friendly adjustment, it will flawlessly secure the helmet around the head.



ERGO DIVIDER | STRAPS

We have developed new ergonomic strap dividers to ensure stability, flush comfort over the skin and simple fitting. No struggling with the adjustments anymore, once tuned to your head it will keep its setting for a superior riding experience.



3D AIR FRAME | ADAPTIVE BAND

Our latest generation AirFrame Band has been re-engineered for an even more advanced air flow control; its seamless 3D geometry is designed to distribute ventilation from the front ports through the inner channels helping concretely sweat management; coupled with the adaptive bands connected directly to the retention system, it ensures stability, superior safety and phenomenal 360° comfort fit.



BUGSTOP PADDING | TECHNOLOGY

The "Bugstop Padding" technology offers a vital layer of protection and comfort. This feature includes a fully perforated net lining within the helmet, designed to prevent direct contact between any insects that may enter the helmet and the rider's head. Despite its protective capabilities, the Bugstop Padding maintains excellent breathability, ensuring proper ventilation and comfort. This innovative design combines safety with an optimal airflow for a more enjoyable riding experience..



helmets technology

360° COMFORT FIT | TECHNOLOGY

The 360° Comfort Fit technology in Rudy Project helmets is designed to provide an unparalleled fit and stability. This advanced feature refers to the retention system's encompassing ring that wraps around the entire circumference of the head, ensuring perfect comfort at every point of contact with the skull. By evenly distributing pressure and securing the helmet firmly in place, the 360° Comfort Fit technology enhances overall stability, reducing helmet movement.



FASTEX CLOSURE | TECHNOLOGY

The "Fastex Closure" technology in Rudy Project helmets features a classic, quick-release buckle system designed for ease and efficiency. This press-button closure allows for fast and secure fastening and unfastening of the helmet, ensuring a snug and reliable fit every time. The Fastex Closure is engineered to provide maximum convenience, allowing athletes to adjust their helmets swiftly and with minimal effort, enhancing both comfort and safety during their activities.



FIDLOCK® | CHIN BUCKLE

The compact magnetic industry-leading FidLock® buckle is intuitive, pinch-free and one handed use even wearing your gloves on. This reliable, comfortable and secure system ensures secure protection in a snap.



EYEWEAR PORTS

Building on our experience in manufacturing performance eyewear and helmets since 1985, most of our helmets integrate sunglasses dock to securely stow and access them easily.



QUICK SNAP STRAPS | TECHNOLOGY

The "Quick Snap Straps" technology offers an innovative system for easy and secure removal of helmet straps. Athletes can effortlessly detach the straps for washing or color changes, ensuring optimal hygiene and customization. Engineered for convenience, the system allows quick and safe adjustments without compromising helmet stability or performance. This user-friendly design makes maintaining and personalizing your helmet simpler than ever, providing functionality and versatility to meet every athlete's needs.



MAGNETIC VISOR | TECHNOLOGY

The "Magnetic Visor" technology in Rudy Project helmets offers a revolutionary pre-activity solution. Strategically placed magnetic elements allow for effortless visor installation and removal. Designed for pre-activity use, the visor can be quickly attached or detached, providing athletes with flexibility and ease. The system also includes secure points for storing the visor in a rest position on the helmet when not in use, ensuring it remains safely stowed and accessible.

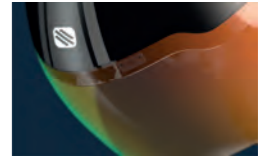

ADJUSTABLE VISOR | TECHNOLOGY

The "Magnetic Visor" technology in Rudy Project helmets offers a revolutionary pre-activity solution. Strategically placed magnetic elements allow for effortless visor installation and removal. Designed for pre-activity use, the visor can be quickly attached or detached, providing athletes with flexibility and ease. The system also includes secure points for storing the visor in a rest position on the helmet when not in use, ensuring it remains safely stowed and accessible.





aerodynamics vs. internal ventilation?

These two elements are most often at odds in the development of an aerodynamic helmet. A very ventilated helmet provokes turbulence which negatively affects aerodynamics, but ventilation benefits physical performance. Because overall performance is what matters most for an athlete, we have conducted extensive testing in the wind tunnel to find the right balance of aerodynamics and ventilation for the development of the Rudy Project helmet collection.

Triathletes and cyclists often face the most important races of the season in hot and humid weather conditions. These conditions can lead to deterioration, sometimes substantial, of physical performance. Training sessions and races at temperatures above 30-32 degrees Celsius with high relative humidity increase the workload of the cardiovascular, nervous, and metabolic systems due to rising core body temperature.

In addition to weather conditions, physical exertion also contributes to the increase of internal body temperature. This rise is directly correlated with the intensity of the effort. The human body, particularly that of an athlete, is able to modulate these variations by regulating core temperatures through a series of behavioral and physiological interventions. During physical exercise, core temperature increases, especially in hot, humid conditions, and can exceed the normal 36.5-37.5 degree range to as much as 40 degrees centigrade. It should be remembered that at temperatures above 41 degrees centigrade, cellular functions begin to deteriorate. When the internal temperature rises, the body's natural thermostat (hypothalamus), located in the brain, triggers a series of defense mechanisms (primarily sweating for evaporative cooling) to dissipate heat.

During physical activity in favorable climatic conditions, the heart provides oxygen through the blood to active muscles, organs, and tissues. When heat and humidity increase, the heart is subjected to an additional workload because it must pump more blood to the skin in order to promote the evaporation of sweat. For this reason, less blood reaches the muscles. The heart rate increases with effort, and therefore the filling time of the heart is reduced with a consequent decrease in cardiac output, leading to a worsening of performance.

When the internal body temperature begins to increase significantly during physical exercise, even the central nervous system enacts defense mechanisms to contain the production of heat. In particular, it reduces muscle recruitment by deactivating part of the muscles involved in the effort in order to avoid health risks. The inevitable consequence is the reduction of performance capacity.

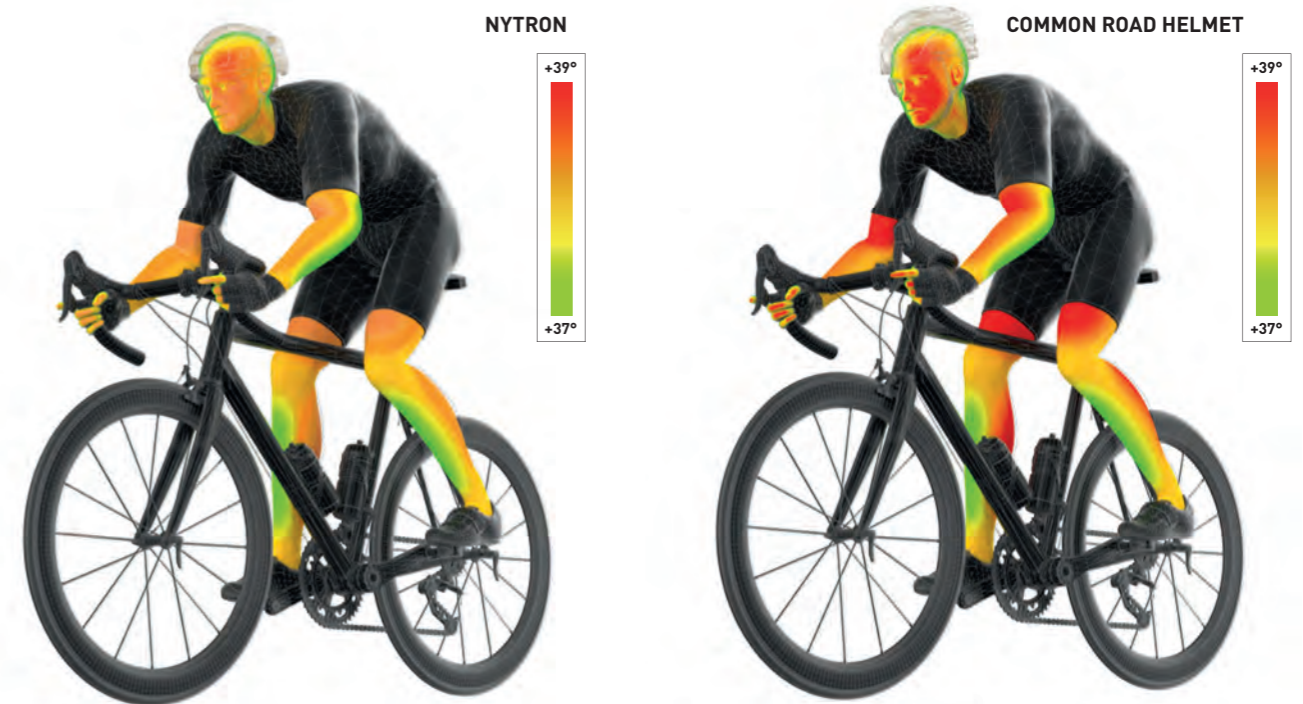

There is an infinite number of scientific studies showing that during endurance physical activities, body heating and the significant increase in core temperature tend to increase brain response times, decrease response accuracy, and generally affect physical capabilities. It is also widely demonstrated that head cooling is able to counteract these tendencies by mitigating the negative effects of increasing internal body temperature.

Further scientific contributions have shown that scalp temperature can be considered an important factor in perceived head and overall body comfort, even in scenarios where the internal body temperature remains high. During physical exercise in high heat and humidity, the subjective perception of increased fatigue and workload on the cardiovascular system with consequent decrease in performance is certainly related to the increase in skin temperature, as well as an increase in internal body temperature, which causes critical decreases in cognitive performance.

A helmet with superior internal ventilation ensures greater heat dissipation, and therefore better thermoregulation and homeostasis of the body's internal temperature, to the benefit of the athlete's performance capabilities.

Roberto Corsetti - Sports Doctor









time trial | 45 km/h (50km/h wind speed)



- simulation setup: 75kg rider, 8.5kg bike, aero drag (baseline) cda 0.250
- * course: 70.3 ironman 90km with 500m climbing
full ironman 180km with 1000m climbing
- power output: 200W average (typical age group athlete on long distance ironman)
- helmets tested in M size

45°

MODEL	AERO D AG		TIME SAVED *		INTERNAL VENTILATION
	MERIT AERO ABSOLUTE (W)	MERIT AERO DELTA (W)	IRONMAN 70.3	FULL DISTANCE IRONMAN (S)	COOLING CHANGE (%) MEASURING on COOLING MANNEQUIN
WINGDREAM 	214,1	-16,6	-153	-306	-32%
THE WING (vents closed) 	216,8	-13,9	-129	-258	-37%
THE WING (vents open) 	217,5	-13,2	-124	-248	-13%
NYTRON PRO 	223	-7,7	-71	-142	-20%
NYTRON 	226,7	-4,0	-37	-74	-10%
REBEL 	230,7	0,0	0	0	0%

BIKE HELMETS

SWISSIDE NO.1 IN AERODYNAMICS WIND TUNNEL TESTING SESSION THIS REPORT SHOWS A PRIVATE WIND TUNNEL SESSION DIRECTED BY SWISS SIDE, THE NUMBER ONE COMPANY IN AERODYNAMICS, TO COLLECT SCIENTIFIC DATA ON THE PERFORMANCE OF OUR AERO HELMETS.



FALLS CAN PROVE TO BE VERY COSTLY AND HAVE PERMANENT OR EVEN LETHAL CONSEQUENCES. THE STARTING POINT FOR THE DEVELOPMENT OF RUDY PROJECT'S HELMETS IS THE ADOPTION OF ONLY HIGHLY-ADVANCED MATERIALS WHICH CAN ABSORB SHOCKS AND DISSIPATE THE MECHANICAL ENERGY WITHOUT IT BEING TRANSFERRED TO THE HEAD AND BODY.

Our bicycle helmets, depending on the design and market of destination, comply with the provisions of Module B of the Regulation (EU) 2016/425 "Personal Protective Equipment" and with the national standard transposing the harmonized standard(s) EN 1078:2012+A1:2012 "Helmets for pedal cyclists and for users of skateboards and roller skates" for PPE of Class II, or with American safety standard "CPSC § 12.03 U.S. Consumer Product Safety Commission Safety Standard for Bicycle Helmets for Persons Age 5 and Older."

Check carefully the markers and informations placed on the labels placed on the product and on its packaging to verify the security standards are fulfilled by the helmet. A copy of the declaration of conformity could be downloaded from the website www.rudyproject.com/warranties.

All the Rudy Project helmets are tested in the production sites and by the independent certification authorities.

The purpose of a bike helmet is to protect the rider's head by absorbing the impact energy through the partial, and not always visible, destruction of the helmet itself, including the compression of the interior EPS foam liner.

To be an effective protection for the head/brain, bike helmets have to meet a number of conditions that test how well they perform in an impact, including the strength of the retention system and their stability of the on the wearer's head.

To ensure a uniform standard of safety testing for bicycle helmets, many countries have adopted bike helmet certification standards with which manufacturers and importers must comply.

All the Rudy Project bicycle helmets, depending on the market of destination, comply with one of the following Standards:

CE/EN 1078

Created in 1997, the EN 1078 Standard was approved in 2012 by the European Committee for Standardization (CEN) and amended the same year into the EN 1078:2012+A1:2012 standard for all cycling, skateboarding and roller skating helmets sold in Europe.

The EN 1078 Standard covers helmet construction including field of vision, shock absorbing properties, retention system properties including chin strap and fastening devices, as well as marking and information.

The standard's key features are:

- Test anvils: Flat and kerbstone
- Drop apparatus: Guided free fall
- Ambient, Hot, Cold and wet conditioning
- Impact velocity, energy or drop height flat anvil: 5.42-5.52 m/s
- Impact energy criteria: < 250g
- Roll-off test
- Retention system strength: Force applied dynamically. Helmet supported on headform.

CPSC / CPSC 12.03

In the United States, The Consumer Product Safety Commission (CPSC) was tasked by Congress with the development of a U.S. Government standard for bicycle helmets and began to do so in 1994. After working with an ASTM task group and producing two drafts for public comment, the third and final draft was approved in February of 1998 and the final version of the standard was published. One interpretation letter has been issued since that time. The standard covers all helmets produced for the US market after March 10, 1999.

The CPSC 1203 Standard covers helmet construction including field of vision, shock absorbing properties, retention system properties including chin strap and fastening devices, as well as marking and information.

The standard's key features are:

- Test anvils: Flat, kerbstone and hemispheric
- Drop apparatus: Guided free fall
- Ambient, Hot, Cold and wet conditioning
- Impact velocity, energy or drop height flat anvil: 2 m
- Impact energy criteria: < 300g
- Roll-off test
- Retention system strength: Force applied dynamically. Helmet supported on headform.

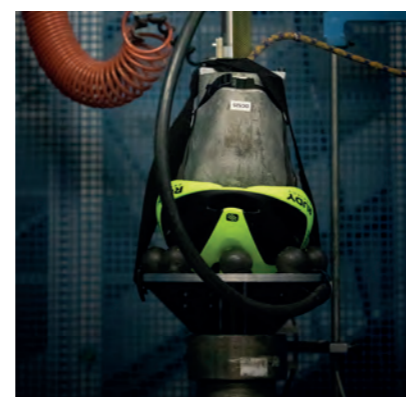
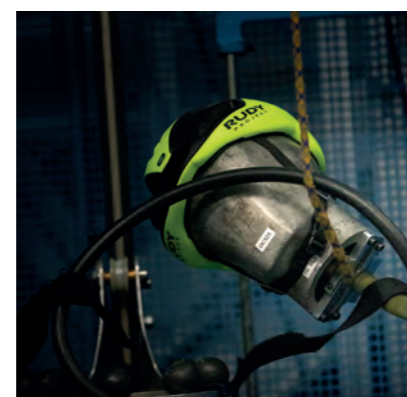

rp rotational impact test

Currently, nearly each research group active within helmet safety has its own definition of helmet safety.

An official Standard that allows measuring and quantifying oblique impact and combines the insight of the different experts would provide a more objective framework of about helmets safety.

On this purpose, CEN (THE EUROPEAN COMMITTEE FOR STANDARDIZATION), through the Technical Committee TC 158 which is dedicated to the head protection and the eight Working Groups currently active under it, is developing a method for measuring the absorption of energy from oblique or normal impacts

The Working Group directly focused on that is known as the CEN TC 158 / Working Group 11.

At Rudy Project we are committed to develop products aiming to the highest level of safety, exceeding the current requirements set by international Standards, such as the CE or CPSC norms.

Today more than ever our goal is to go even further by overpassing also the RP ROTATIONAL IMPACT TEST.

The RP ROTATIONAL IMPACT TEST is an internal protocol adopted by Rudy Project, in cooperation with accredited and notified bodies, to test and measure the performance of the helmets against rotational impacts; it takes inspiration from CEN, from ECE 22.06 (a new standard for motorcycle helmets) and it is based on real accident data and scientific sources.

The RP ROTATIONAL IMPACT TEST "pass-fail" criterion is based on the BRIC (Brain Injury Criterion) value, an algorithm that defines the level of brain injury. This value must be less than 0,68.

*The RP ROTATIONAL IMPACT TEST is a RUDY PROJECT internal protocol to test and measure the performance of the RUDY PROJECT helmets against rotational impacts. This test has not been adopted by CEN or by its Working Group CEN TC 158 / Working Group 11.

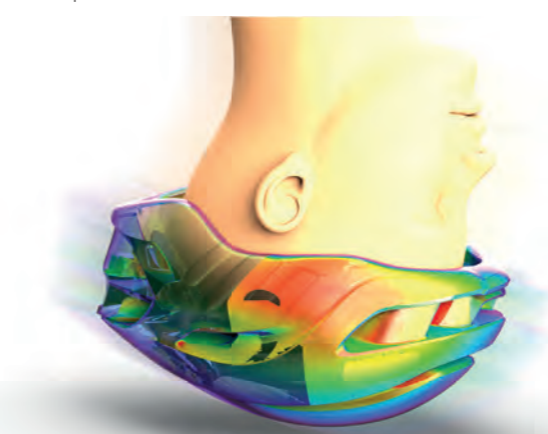

RP ROTATIONAL IMPACT TEST

- oblique tests @ 45° on X,Y and Z axis
- impact speed 6 m/s, BRIC < 0,68
- grade 80 closed-coat aluminum oxide abrasive paper
- headform nominal coefficient of friction 0,3
- wireless system: triaxial accelerometer + n. 3 ARS
- Headform: EN960 serie
- Measurements: Peak of rotational acceleration, Peak of linear acceleration, HIC, BRIC (< 0,68)

WINGDREAM, REBEL EGOS, NYTRON, SPECTRUM, VENGER, VENGER CROSS, PROTERA+ SUCCESSFULLY PASSED RP ROTATIONAL IMPACT TEST





S-M 55-58 cm / 21,7" - 22,8"
L 59-61 cm / 23,2" - 24"

CE version:
S-M g: 490 / o: 17,3
L g: 460 / o: 16,2

AVAILABLE STANDARDS:
 CE/EN 1078. CPSC 12.03



BLACK (MATTE)
 HL 85 00 11 S - M
 HL 85 00 12 L



WHITE (MATTE)
 HL 85 00 01 S - M
 HL 85 00 02 L



Wingdream NEW

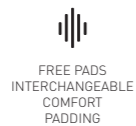
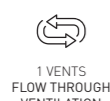

INCLUDED

- Removable magnetic visor (multilaser orange)
- Microfiber pouch
- Interchangeable free pads
- RSR 11 S Retention System

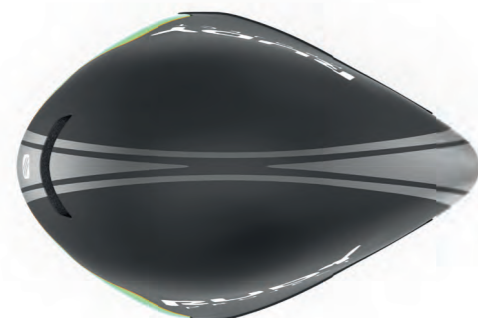

SPARE PARTS



FREE PADS
 Interchangeable
 internal padding
 Black
CO 00 04 09



RSR 11 S
 Retention System Kit
 Light Grey / Black
CO 00 04 60



REMOVABLE SHIELD
 Multilaser Orange
LH 85 40



REMOVABLE SHIELD
 Transparent
LH 85 11

HELMET CASE



dimension:
 27x31x40 cm
AC 08 00 89



S-M 55-58 cm / 21,7" - 22,8"
L 59-61 cm / 23,2" - 24"

CE version:
S-M g: 320 / o: 11,3
L g: 360 / o: 12,7

AVAILABLE STANDARDS:
CE/EN 1078 - CPSC 12.03



WHITE (SHINY)
HL 73 00 01 S - M
HL 73 00 02 L



BLACK (MATTE)
HL 73 00 11 S - M
HL 73 00 12 L



COSMIC BLUE (MATTE)
HL 73 00 61 S - M
HL 73 00 62 L



The Wing

-  2 VENTS FLOW THROUGH VENTILATION
-  DIVIDER PRO SIDE BUCKLES
-  FASTEX SYSTEM CLOSURE BUCKLE
-  TOTAL COMFORT FIT
-  RSR 10 SM ADJUSTABLE RETENTION SYSTEM
-  FREE PADS INTERCHANGEABLE COMFORT PADDING
-  ADAPTIVE AIRFRAME BAND

- INCLUDED**
- Removable shield
 - Removable vent cover
 - Microfiber pouch
 - Interchangeable free pads
 - RSR 10SM Retention System



SPARE PARTS

NEW HELMET CASE



FREE PADS
Interchangeable internal padding
Black
CO 00 04 09



RSR 10 SM
Retention System Kit
Mirror Chrome
CO 00 04 39



REMOVABLE SHIELD
Laser Black
LH 73 09



REMOVABLE SHIELD
Transparent
LH 73 11



REMOVABLE SHIELD
Multilaser Orange
LH 73 40



dimension:
27x31x40 cm
AC 08 00 89



S-M 55-58 cm / 21,7" - 22,8"
L 59-61 cm / 23,2" - 24"

CE version:
S-M g: 250 / o: 8,8
L g: 300 / o: 10,6

AVAILABLE STANDARDS:
 CE/EN 1078. CPSC 12.03



NEW

RED COMET (SHINY)
 HL 77 01 11 S - M
 HL 77 01 12 L



BLACK (MATTE)
 HL 77 00 01 S - M
 HL 77 00 02 L



WHITE (MATTE)
 HL 77 00 11 S - M
 HL 77 00 12 L



BLUE METAL (SHINY) - BLACK (MATTE)
 HL 77 00 81 S - M
 HL 77 00 82 L



PINK FLUO - BLACK (MATTE)
 HL 77 00 91 S - M
 HL 77 00 92 L

Nytron



RP
**ROTATIONAL
 IMPACT TEST**



**15 VENTS
 FLOW THROUGH
 VENTILATION**



**DIVIDER PRO
 SIDE BUCKLES**



**FASTEX SYSTEM
 CLOSURE BUCKLE**



**RSR 10 M
 ADJUSTABLE
 RETENTION
 SYSTEM**



**FREE PADS
 INTERCHANGEABLE
 COMFORT
 PADDING**

INCLUDED:

- Microfiber pouch
- Free pads interchangeable
- RSR 10 M Retention System



SPARE PARTS



FREE PADS
 Black
 C0 00 04 51



RSR 10 M
 Retention System Kit
 Mirror Chrome
 C0 00 04 21



S-M 55-58 cm / 21,7" - 22,8"
L 59-61 cm / 23,2" - 24"

CE version:
S-M g: 320 / o: 11,3
L g: 360 / o: 12,7

AVAILABLE STANDARDS:
 CE/EN 1078. CPSC 12.03



WHITE IRIDESCENT (MATTE)
 HL 84 00 01 S - M
 HL 84 00 02 L



Nytron Pro



3 VENTS
FLOW THROUGH
VENTILATION

DIVIDER PRO
SIDE BUCKLES

FASTEX SYSTEM
CLOSURE BUCKLE

RSR 10 M
ADJUSTABLE
RETENTION
SYSTEM

FREE PADS
INTERCHANGEABLE
COMFORT
PADDING

- INCLUDED:**
- Microfiber pouch
 - Free pads interchangeable
 - RSR 10 M Retention System



SPARE PARTS



FREE PADS
 Black
 C0 00 04 51



RSR 10 M
 Retention System Kit
 Mirror Chrome
 C0 00 04 21

FEATURES



WIND TUNNEL-OPTIMIZED
 FOR THE SPECIFIC HEAD
 POSITION OF ROAD CYCLISTS

+2W

IMPROVES AERODYNAMICS
 BY 2 WATTS OVER
 STANDARD NYTRON

-11%

SLIGHT 11% REDUCTION
 IN INTERNAL VENTILATION



S-M 55-58 cm / 21,7" - 22,8"
L 59-61 cm / 23,2" - 24"

CE version:
S-M g: 250 / o: 8,8
L g: 280 / o: 9,9

AVAILABLE STANDARDS:
 CE/EN 1078. CPSC 12.03



CARBON BLACK (MATTE)
 HL 74 00 01 S-M
 HL 74 00 02 L



CARBON WHITE (MATTE)
 HL 74 00 11 S-M
 HL 74 00 12 L



CARBON RED COMET (SHINY)
 HL 74 00 21 S-M
 HL 74 00 22 L



Rebel NEW

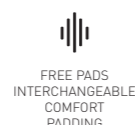

INCLUDED:

- Microfiber pouch
- Free pads interchangeable
- Bug stop interchangeable
- RSR 11 S Retention System



BUG STOP
 Interchangeable internal padding with bug stop
 Black
C0 00 04 88



FREE PADS
 Interchangeable internal padding
 Black
C0 00 04 87



RSR 11 S
 Retention System Kit
 Light Grey / Black
C0 00 04 60



RECYCLED MATERIAL





S 51-55 cm / 20,1" - 21,7"
 M 55-59 cm / 21,7" - 23,2"
 L 59-63 cm / 23,2" - 24,8"

CE version:
 S g: 230 / o: 8,1
 M g: 250 / o: 8,8
 L g: 280 / o: 9,9

AVAILABLE STANDARDS:
 CE/EN 1078. CPSC 12.03



NEW

BLACK / PINK FLUO (MATTE)
 HL 78 01 40 S
 HL 78 01 41 M
 HL 78 01 42 L



BLACK (MATTE)
 HL 78 00 00 S
 HL 78 00 01 M
 HL 78 00 02 L



WHITE (MATTE)
 HL 78 00 10 S
 HL 78 00 11 M
 HL 78 00 12 L



RED COMET - BLACK (SHINY)
 HL 78 01 20 S
 HL 78 01 21 M
 HL 78 01 22 L

Egos



23 VENTS
 FLOW THROUGH
 VENTILATION

DUAL DENSITY



ERGO DIVIDER
 SIDE BUCKLES



FIDLOCK
 CLOSURE BUCKLE



TOTAL
 COMFORT FIT



RSR 11
 ADJUSTABLE
 RETENTION
 SYSTEM



BUGSTOP
 PADDING WITH
 PROTECTIVE
 NET



FREE PADS
 INTERCHANGEABLE
 COMFORT
 PADDING



ADAPTIVE
 AIRFRAME
 BAND

INCLUDED:

- Microfiber pouch
- Free pads interchangeable
- RSR 11 Retention System



SPARE PARTS



BUG STOP
 Interchangeable internal
 padding with bug stop
 Black
 CO 00 04 75



FREE PADS
 Interchangeable
 internal padding
 Black
 CO 00 04 76



RSR 11
 Retention System Kit
 Black / Grey
 CO 00 04 59



S 51-55 cm / 20,1" - 21,7"
M 55-59 cm / 21,7" - 23,2"
L 59-63 cm / 23,2" - 24,8"

CE version:
S g: 230 / o: 8,1
M g: 260 / o: 9,2
L g: 300 / o: 10,6

AVAILABLE STANDARDS:
 CE/EN 1078, CPSC 12.03, AS/NZS 2063



BLACK (MATTE)
 HL 65 01 30 S
 HL 65 01 31 M
 HL 65 01 32 L



WHITE (MATTE)
 HL 65 01 40 S
 HL 65 01 41 M
 HL 65 01 42 L



RED - BLACK (MATTE)
 HL 65 01 10 S
 HL 65 01 11 M
 HL 65 01 12 L



Spectrum



15 VENTS
FLOW THROUGH
VENTILATION

DIVIDER PRO
SIDE BUCKLES

FASTEX SYSTEM
CLOSURE BUCKLE

TOTAL
COMFORT FIT

RSR 10 M
ADJUSTABLE
RETENTION
SYSTEM

BUGSTOP
PADDING WITH
PROTECTIVE
NET

FREE PADS
INTERCHANGEABLE
COMFORT
PADDING

ADAPTIVE
AIRFRAME
BAND

INCLUDED:

- Free pads interchangeable
- Bug stop interchangeable
- RSR 10 M Retention System



SPARE PARTS



BUG STOP
 Interchangeable internal
padding with bug stop
Black
 CO 00 04 25



FREE PADS
 Interchangeable
internal padding
Black
 CO 00 04 26



RSR 10 M
 Retention System Kit
Mirror Chrome
 CO 00 04 21



S-M 55-58 cm / 21,7" - 22,8"
L 59-61 cm / 23,2" - 24"

CE version:
S-M g: 360 / o: 12,7
L g: 370 / o: 13

AVAILABLE STANDARDS:
 CE/EN 1078. CPSC 12.03



BLACK (MATTE)
 HL 80 00 91 S - M
 HL 80 00 92 L



SAND (MATTE)
 HL 80 01 11 S - M
 HL 80 01 12 L



LAGOON (MATTE)
 HL 80 01 21 S - M
 HL 80 01 22 L

Protera+



18 VENTS
 FLOW THROUGH
 VENTILATION

DIVIDER PRO
 SIDE BUCKLES

FASTEX SYSTEM
 CLOSURE BUCKLE

QUICK SNAP
 STRAPS

RSR 9
 ADJUSTABLE
 RETENTION
 SYSTEM

BUGSTOP
 PADDING WITH
 PROTECTIVE
 NET

FREE PADS
 INTERCHANGEABLE
 COMFORT
 PADDING

SNAP
 RETAINER

ADAPTIVE
 AIRFRAME BAND

INCLUDED

- Visor adjustable
- Free pads interchangeable
- Bug stop interchangeable
- Strap retainer
- RSR 9 Retention System



SPARE PARTS



BUG STOP
 Interchangeable internal
 padding with bug stop
 Black
 C0 00 03 91



RSR 9
 Retention System Kit
 Black / Grey
 C0 00 04 06



VISOR
 Black
 AC 40 00 64



VISOR
 Sand Matte
 AC 40 00 75



VISOR
 Lagoon Matte
 AC 40 00 76



FREE PADS
 Interchangeable
 internal padding
 Black
 C0 00 03 92



SPARE STRAPS
 Black
 C0 00 03 97



STRAP RETAINER
 Black
 C0 00 04 34





STRAP RETAINER
 Sand Matte
 C0 00 04 73



STRAP RETAINER
 Lagoon Matte
 C0 00 04 74



 **S** 51-55 cm / 20,1" - 21,7"
M 55-59 cm / 21,7" - 23,2"
L 59-63 cm / 23,2" - 24,8"

 **CE version:**
S g: 240 / o: 8,5
M g: 260 / o: 9,2
L g: 280 / o: 9,9

AVAILABLE STANDARDS:
 CE/EN 1078. CPSC 12.03



BLACK (MATTE)
 HL 66 00 40 S
 HL 66 00 41 M
 HL 66 00 42 L



WHITE (MATTE)
 HL 66 00 70 S
 HL 66 00 71 M
 HL 66 00 72 L



LIGHT GREY - BLACK (MATTE)
 HL 66 00 50 S
 HL 66 00 51 M
 HL 66 00 52 L



METAL GREEN (SHINY) /BLACK MATTE
 HL 66 00 60 S
 HL 66 00 61 M
 HL 66 00 62 L

Venger Cross

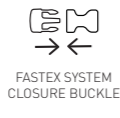

22 VENTS
FLOW THROUGH
VENTILATION

DIVIDER PRO
SIDE BUCKLES

FASTEX SYSTEM
CLOSURE BUCKLE

TOTAL
COMFORT FIT

RSR 10
ADJUSTABLE
RETENTION
SYSTEM

BUGSTOP
PADDING WITH
PROTECTIVE
NET

FREE PADS
INTERCHANGEABLE
COMFORT
PADDING

ADAPTIVE
AIRFRAME BAND

INCLUDED

- 1 Visor
- Free pads interchangeable
- Bug stop interchangeable
- RSR 10 Retention System



SPARE PARTS



BUG STOP
 Interchangeable internal
padding with bug stop
Black
CO 00 04 10



FREE PADS
 Interchangeable
internal padding
Black
CO 00 04 11



RSR 10
 Retention System Kit
Black / Grey
CO 00 04 20





VISOR
 White
AC 40 00 68



VISOR
 Black
AC 40 00 72



 **S** 51-55 cm / 20,1" - 21,7"
M 55-59 cm / 21,7" - 23,2"
L 59-63 cm / 23,2" - 24,8"

 **CE version:**
S g: 220 / o: 7,8
M g: 240 / o: 8,5
L g: 260 / o: 9,2

AVAILABLE STANDARDS:
 CE/EN 1078. CPSC 12.03



TITANIUM - BLACK (MATTE)
 HL 66 01 10 S
 HL 66 01 11 M
 HL 66 01 12 L



WHITE - SILVER (MATTE)
 HL 66 01 00 S
 HL 66 01 01 M
 HL 66 01 02 L



RED - BLACK (MATTE)
 HL 66 01 50 S
 HL 66 01 51 M
 HL 66 01 52 L



IRIDESCENT BLUE (SHINY)
 HL 66 01 70 S
 HL 66 01 71 M
 HL 66 01 72 L

Venger



 22 VENTS
 FLOW THROUGH
 VENTILATION

 DIVIDER PRO
 SIDE BUCKLES

 FASTEX SYSTEM
 CLOSURE BUCKLE

 TOTAL
 COMFORT FIT

 RSR 10
 ADJUSTABLE
 RETENTION
 SYSTEM

 BUGSTOP
 PADDING WITH
 PROTECTIVE
 NET

 FREE PADS
 INTERCHANGEABLE
 COMFORT
 PADDING

 ADAPTIVE
 AIRFRAME BAND

- INCLUDED:**
- Free pads interchangeable
 - Bug stop interchangeable
 - RSR 10 Retention System

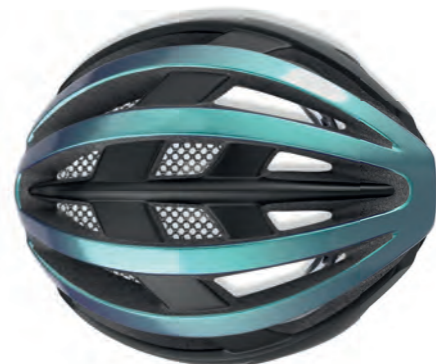

HIGHLY REFLECTIVE



GUN MATTE - (SHINY)
 HL 66 11 00 S
 HL 66 11 01 M
 HL 66 11 02 L



YELLOW MATTE - (SHINY)
 HL 66 11 10 S
 HL 66 11 11 M
 HL 66 11 12 L

SPARE PARTS



BUG STOP
 Interchangeable internal
 padding with bug stop
 Black
 CO 00 04 10



FREE PADS
 Interchangeable
 internal padding
 Black
 CO 00 04 11



RSR 10
 Retention System Kit
 Mirror Chrome
 CO 00 04 20



S-M 55-58 cm / 21,7" - 22,8"
L 59-61 cm / 23,2" - 24"

CE version:
S-M g: 250 / o: 8,8
L g: 270 / o: 9,5

AVAILABLE STANDARDS:
 CE/EN 1078. CPSC 12.03



LEAD / BLACK (MATTE)
 HL 76 00 11 S-M
 HL 76 00 12 L



WHITE - (MATTE)
 HL 76 00 01 S-M
 HL 76 00 02 L



BLACK/RED (SHINY)
 HL 76 00 41 S-M
 HL 76 00 42 L









LIGHT GREY (MATTE)
 HL 76 00 61 S-M
 HL 76 00 62 L



LAGOON (MATTE)
 HL 76 00 71 S-M
 HL 76 00 72 L

Crossway

-  23 VENTS FLOW THROUGH VENTILATION
-  DIVIDER PRO SIDE BUCKLES
-  FASTEX SYSTEM CLOSURE BUCKLE
-  TOTAL COMFORT FIT
-  RSR 10 S ADJUSTABLE RETENTION SYSTEM
-  BUGSTOP PADDING WITH PROTECTIVE NET

- INCLUDED**
- 1 Visor
 - Free pads interchangeable
 - Bug stop interchangeable
 - RSR 10 S Retention System



SPARE PARTS



BUG STOP
 Interchangeable internal padding with bug stop
 Black
 CO 00 04 44



RSR 10 S
 Retention System Kit
 Black / Grey
 CO 00 04 43



S-M 55-58 cm / 21,7" - 22,8"
L 59-61 cm / 23,2" - 24"

CE version:
S-M g: 250 / o: 8,8
L g: 270 / o: 9,5

AVAILABLE STANDARDS:
 CE/EN 1078. CPSC 12.03



BLACK (MATTE)
 HL 79 00 01 S - M
 HL 79 00 02 L



WHITE (SHINY)
 HL 79 00 11 S - M
 HL 79 00 12 L



SAND (SHINY)
 HL 79 00 21 S - M
 HL 79 00 22 L



MANGO (SHINY)
 HL 79 00 31 S - M
 HL 79 00 32 L



TEAL (SHINY)
 HL 79 00 41 S - M
 HL 79 00 42 L



PINK FLUO - BLACK (MATTE)
 HL 79 00 51 S - M
 HL 79 00 52 L

Skudo

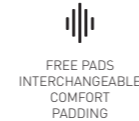
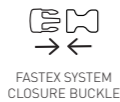
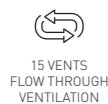

15 VENTS
FLOW THROUGH
VENTILATION

ERGO DIVIDER
SIDE BUCKLES

FASTEX SYSTEM
CLOSURE BUCKLE

TOTAL
COMFORT FIT

RSR 11 S
ADJUSTABLE
RETENTION
SYSTEM

BUGSTOP
PADDING WITH
PROTECTIVE
NET

FREE PADS
INTERCHANGEABLE
COMFORT
PADDING

ADAPTIVE
AIRFRAME BAND

INCLUDED:
 • Free pads interchangeable
 • RSR 11 S Retention System



SPARE PARTS



BUG STOP
 Interchangeable internal
padding with bug stop
Black
 CO 00 04 77



RSR 11 S
 Retention System Kit
 CO 00 04 60



S-M 55-58 cm / 21,7" - 22,8"
L 59-61 cm / 23,2" - 24"

CE version:
S-M g: 250 / o: 8,8
L g: 270 / o: 9,5

AVAILABLE STANDARDS:
 CE/EN 1078, CPSC 12.03, AS/NZ S2063



BLACK (SHINY)
 HL 82 00 01 S - M
 HL 82 00 02 L



WHITE (SHINY)
 HL 82 00 11 S - M
 HL 82 00 12 L



RED (SHINY)
 HL 82 00 21 S - M
 HL 82 00 22 L



LAGOON (SHINY)
 HL 82 00 31 S - M
 HL 82 00 32 L

Strym Z

- 16 VENTS
FLOW THROUGH
VENTILATION
- DIVIDER PRO
SIDE BUCKLES
- FASTEX SYSTEM
CLOSURE BUCKLE
- TOTAL
COMFORT FIT
- RSR 10
ADJUSTABLE
RETENTION
SYSTEM
- ADAPTIVE
AIRFRAME BAND
- FREE PADS
INTERCHANGEABLE
COMFORT
PADDING

- INCLUDED:**
- Free pads interchangeable
 - RSR 10 Retention System



SPARE PARTS



BUG STOP
 Interchangeable internal
padding with bug stop
Silver
CO 00 04 78



RSR 10
 Retention System Kit
 Black / Grey
CO 00 04 20



helmet sizing | fitting

CM	48.2	51.1	52	53	53.9	54.9	55.8	56.8	57.7	58.7	59.6	60.6	61.5	62.5
INCHES	19	20 ¹ / ₈	20 ¹ / ₂	20 ⁷ / ₈	21 ¹ / ₄	21 ⁵ / ₈	22	22 ³ / ₈	22 ³ / ₄	23 ¹ / ₈	23 ¹ / ₂	23 ⁷ / ₈	24 ¹ / ₄	24 ⁵ / ₈
CAP SIZE	6	6 ³ / ₈	6 ¹ / ₂	6 ⁵ / ₈	6 ³ / ₄	6 ⁷ / ₈	7	7 ¹ / ₈	7 ¹ / ₄	7 ³ / ₈	7 ¹ / ₂	7 ⁵ / ₈	7 ³ / ₄	7 ⁷ / ₈

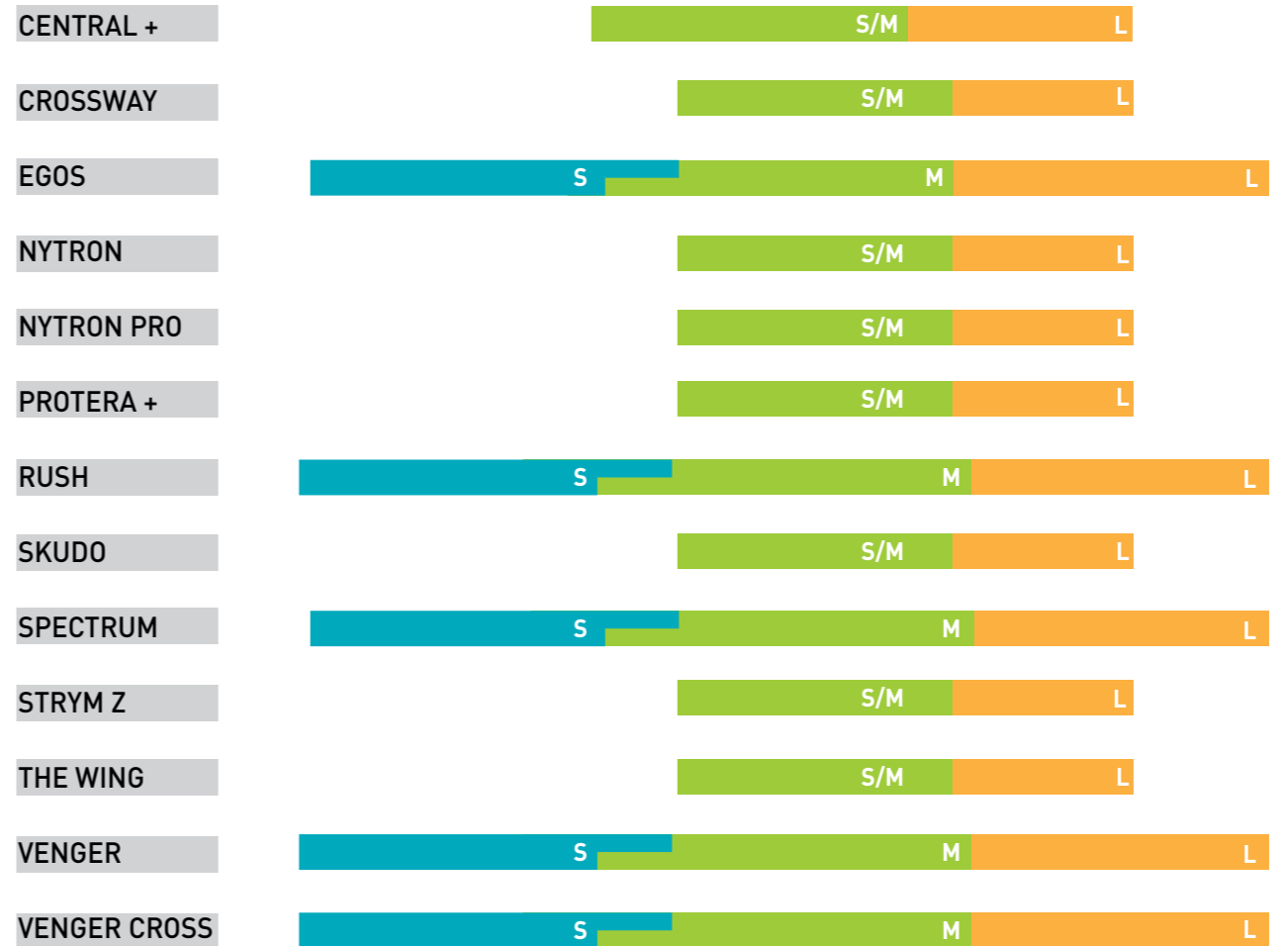

helmet sizing guide.

- 01** LOCATE MEASURING INSTRUMENT
Locate a pliable measuring ribbon or a mobile charging cable (and a straightedge to compare it against).
- 02** TAKE MEASUREMENT
Encircle the cable around your head slightly over the brow line.
- 03** DETERMINE YOUR SIZE
Consult the table above to identify your fitting. If you're between two dimensions, opt for the smaller one.



snow



SNOW

GOLF

 **made in italy**

 g: 123
o: 4,3



Spincut

 **OTG**
INTERCHANGEABLE LENS OVER THE GLASS

REPLACEMENT LENSES

impactx

LK 21 75 ImpactX Photochromic 2 Laser Purple

RP OPTICS

LK 21 45 Multilaser Ice (Cat. 3)
LK 21 57 Multilaser Gold (Cat. 3)
LK 21 40 Multilaser Orange (Cat. 3)
LK 21 21 Laser Kayvon Red (Cat. 2)

ACCESSORIES

GOGGLE OPTICAL INSERT

The all new RX Goggle Optical Insert is an excellent value solution for prescription wearers. The clip can be effortlessly inserted or removed and is fully compatible with our Skermo and Klonyx Snow goggles.

 p.90
FR 12 00 00



IMPACTX®



BLACK MATTE
ImpactXPhotochromic 2 laser Purple DL
MK 21 75 66 - 0000



LIGHT GREY MATTE
ImpactX Photochromic 2 laser Purple DL
MK 21 75 04 - 0000

RP OPTICS



BLACK GLOSS
Multilaser Gold DL
MK 21 57 03 - 0000



BONDI BLUE
Multilaser Orange DL
MK 21 40 02 - 0000



WHITE GLOSS
Multilaser Ice DL
MK 21 45 69 - 0000



WHITE GLOSS
Kayvon Red DL
MK 21 21 69 - 0000

- Custom foam padding incorporated directly into the goggle frame.
- Rx-ready with our goggle insert.
- Wide cylindrical double lens construction to optimize fitting.
- Innovative quick-change interchangeable system easy-in/easy-out.





g: 187
o: 6,6

Skermo

RX SOLUTIONS
TOTAL COMFORT FIT



RP OPTICS



BLACK MATTE
Multilaser Orange
MK 20 40 06 - 0001



DEEP BLUE MATTE
Multilaser Blue
MK 20 43 59 - 0000

REPLACEMENT LENSES



LK 20 43 Multilaser Blue (Cat. 3)
LK 20 40 Multilaser Orange (Cat. 1)

ACCESSORIES

GOGGLE OPTICAL INSERT

The all new RX Goggle Optical Insert is an excellent value solution for prescription wearers. The clip can be effortlessly inserted or removed and is fully compatible with our Skermo and Klonyx Snow goggles.

p.90
FR 12 00 00



- Twin-buckle removable strap with inner silicone stripes
- Advanced peripheral vision
- RP Optics multilaser antifog double lens
- Triple-layer face foam superior soft comfort
- Helmet compatible sleek cylindrical design
- Low profile PU frame geometry



gear & pop



crew & t-shirt

NEW BASIC COTTON

SIZE: S (2) - M (3) - L (4) - XL (5)



BLACK
RP 15 00 9-



WHITE
RP 15 01 0-

NEW CAPS



BLACK
RP 55 00 04



WHITE
RP 55 00 05

bags & packs

BACKPACK 36

- Dimensions: cm 35 L x cm 50 H x cm 22 W
- Capacity 36 L
- Lightweight and durable construction
- Water-resistant Tarpaulin insert
- Splash waterproof zippers
- Padded dedicated laptop/tablet compartment
- Easy access main compartment with internal zippered pocket
- Front utility pocket
- All-purpose secondary pocket
- Safety reflective inserts
- Ergonomic and adjustable shoulder straps
- Adjustable sternum and hip belts
- Water bottle side mesh compartments
- Hi contrast inner lining

AC 00 30 97 A



GLOVES | ICONIC GLOVES

SIZE: S(2) - M(3) - L(4)



GREY/BLACK
RP 50 20 0-



Retail / Displays



TOWER DISPLAY

CABINET 32

Support for 32 glasses /modular display
PMMA Closed Cabinet with locks
Adaptive shelves
(removable to include counter cards, risers, special packaging, etc.)
Enhanced LED light system
Incorporated mirrors
Storage with key lock
Allows both sides and top Visual magnetic panels
Allows 8 helmets supports
Recycled PMMA Green Cast
Sustainable design
Caster wheels

Dimension:
410 x 420 x 1920 mm
AC 10 11 25 L2

SIDE A

SIDE B

1 PZ. INCLUDED
Dimension:
400 x 460 mm

COUNTER DISPLAY

CABINET 16

Support for 16 glasses
PMMA Closed Cabinet with lock
Enhanced LED light system
Incorporated mirrors
Allow visual magnetic panels on both sides
Recycled PMMA Green Cast
Sustainable design

dimension:
400 mm x 320 mm x 830 mm H

AC 10 11 27 L2



HELMET HANGER

dimension (not packed):
325 mm x 70 mm x 145 mm H
weight: 80 grams - 2,8 ounces

AC 10 10 84 HA



ACRYLIC LOGO SIGN

dimension:
120 mm x 30 mm x 75 mm H

AC 20 00 33



KIT SILENT SALESMAN

KIT SILENT SALESMAN PROMOTIONAL SIGN

PMMA Green Cast, 100% recycled thermoplastic polymer.
dimension: 17mm (H) x 5mm (W)

KIT 7 pcs
AC 07 00 05



- NEW
- PHOTOCHROMIC
- POLARIZED
- BIKE
- RUNNING
- GOLF
- OUTDOOR

SHELF DISPLAY

IMAGE 18X15 CM 3 PZ. INCLUDED

Dimension:
240 x 180 x 170 mm
AC 20 00 32



FLOOR RACK DISPLAY

OPEN 12

Support for 12 glasses
Sarno lock system
Incorporated mirrors
Allows both sides and top
Visual magnetic panels
Allows 8 helmets supports
Recycled PMMA Green Cast
Sustainable design

Dimension:
230 x 420 x 1880 mm
AC 10 11 30



HELMETS DISPLAY

for 12 helmets NOT INCLUDED
dimension (not packed):
850 mm x 420 mm x 1810 mm H
weight: 15 kg - 529 ounces
dimension (packed):
400 mm x 430 mm x 1850 mm H
weight: 16,5 kg - 582 ounces
floor space: 400 mm x 370mm

AC 10 10 44 B



MONOLITH DISPLAY



MONOLITH DISPLAY 1
dimension:
170 mm x 127,5mm H
for 1 sunglass
(not included)

AC 10 11 21 A



MONOLITH DISPLAY 2
dimension:
170 mm x 207,5mm H
for 2 sunglasses
(not included)

AC 10 11 22 A



MONOLITH DISPLAY 3
dimension:
170 mm x 287,5mm H
for 3 sunglasses
(not included)

AC 10 11 23 A

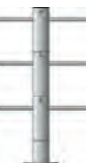

HEAD 3 DISPLAY

dimensions:
cm 21 L x 35 H x 19 W
weight 350 g. - 12,3 ounces
sunglasses NOT INCLUDED Polystyrene

AC 20 00 26



LIGHT ACRYLIC DISPLAY

dimension:
208 mm x 80mm x 320mm H
for 1 helmet and 1 sunglasses
(not included)

AC 10 11 24



retail/merchandising

ACCESSORIES

NEW

JET GREEN
Bottle body bio based,
originate from sugar cane
550 ml
AC 00 00 01 BIB



SHOPPER BAG - LARGE
dimensions 48x34 cm
AC 00 30 04 D



SHOPPER BAG - SMALL
dimensions 27,5x22 cm
AC 00 30 06 F

AUTHORIZED DEALER
door sticker / doubled
sided 11,5 x 4 cm
AC 05 00 82 A



HANDY MIRROR
dimension (not packed):
110 mm x 300 mm H
weight: 300g - 10,5 onces
dimension (packed):
130 mm x 330 mmH
weight: 350 g - 12,3 onces
AC 09 00 05



STICKER PRE-SPACED
white - 8,5 x 1,3 cm
AC 05 13 23 W



RACE BELT
material: elastic
AC 00 10 07



NEOPRENE CORD
for sunglasses
XL (25mm)
AC 21 00 23 A



STICKER PRE-SPACED
black - 8,5 x 1,3 cm
AC 05 13 23 B



NEW

PREMIUM MICROFIBER
microfiber cleaning cloth

small (15x18cm)
AC 08 00 87



extra large (30x40cm)
AC 08 00 88



EYEWEAR PROTECTION - MICROFIBER POUCHES

PROTECTOR CASE

- Recycled Plastic
- Removable eyewear dock



EYEWEAR PATROL PACK
Eyewear Patrol Pack
Low profile thermoformed
nylon case with zip closure
and inner padding protection
Designed to carry any
Rudy Project eyewear
+ 4 pairs of lenses,
or 4 shields.
Additional
compartment
for cleaning cloth.
AC 08 00 41 A



AC 08 00 82 - 1A
Including eyewear dock:
Tralyx+
Tralyx+ Slim
Rydon
Rydon + Readers
Rydon Slim
Cutline
Defender
Magnus
Propulse Readers
Keyblade

AC 08 00 82 - 2A
Including eyewear dock:
Agent Q

AC 08 00 82 - 3A
Including eyewear dock:
Stardash

AC 08 00 82 - 4A
Including eyewear dock:
Kelion

AC 08 00 82 - 5A
Including eyewear dock:
Ophthalmic models

AC 08 00 82 - 6A
Including eyewear dock:
Turbolence

MICROFIBER POUCH
microfiber cloth
AC 08 00 68 E



SPRAY LENS
cleaner
AC 08 00 12 C



EVENT ACCESSORIES / BANNERS

RP - UMBRELLA
Black/White
AC 00 40 00 A

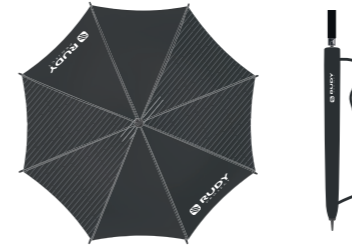

BANNER FLAGS
dimensions 250 cm x 80 cm
AC 05 01 02 C



RP - POLIMESH
dimensions 25mt x 80 H cm
AC 05 01 05 A



FLYING BANNER
AC 05 01 41 A height: 400 cm - LARGE
AC 05 01 46 A height: 220 cm - SMALL



EVENT TENT

EVENT TENT
dimensions: 300 cm x 300 cm
AC 10 00 04 B
AC 10 00 04 B-01 Telo Tetto
AC 10 00 04 B-02 Telo Porta
AC 10 00 04 B-03 kit 3 Teli pareti



retail/pop

Please contact our sales department to get all the information about the windows cards available. You can order the most updated material to decorate your store and grab customers attention.

MAXI WINDOWS CARDS



dimensions:
42 x 29,7 cm

MEDIUM WINDOWS CARDS



dimensions:
21 x 14,8 cm

SMALL WINDOWS CARDS



dimensions:
11 x 20 cm

NEW CARDBOARD DISPLAY SUN DEMO KIT



SUN DEMO KIT

5 ImpactX demo lens
4 Polar lens
1 Multilaser lens

AC 03 00 40

NEW CARDBOARD DISPLAY OPTICAL DEMO KIT



OPTICAL DEMO KIT

RX DIRECT - Rydon, Rydon Slim,
Magnus, Propulse, Sirius, Cutline In-set

RX INSERT - FR 70 00 00

RX OPTICAL DOCK - Deltabeat, Rydon

AC 03 00 41

NEW MASTER SAMPLE CASES

MASTER SAMPLE CASE

96 pcs - (2x48 pcs)
Two separate modules, each carrying 5 individual trays with 6+6 large custom sport/eyewear compartments
Reinforced aluminum structure
Padded nylon ballistic fabric outershell
Sturdy trolley base system with comfortable handles
Inner pocket, panel vecro straps, customisable labels Superior quality finishing
Overall dimensions
450 mm x 455 mm x 950 mm H
AC 03 00 42



NEW SAMPLE CASE 21

SAMPLE CASE 21
dimension:
512 mm x 530 mm x 70 mm H
weight: 1,2 kg - 36,3 onces
for 21 sunglasses (not included)
AC 03 01 12



SMART DISPLAY CARDBOARD 6pcs.

CUSTOMIZABLE BLANK DISPLAY
Interchangeable Box Display
for 6 sunglasses (NOT INCLUDED)
44,5 x 13,5 x 47 H cm
AC 10 02 00 E



CATALOGS



PERFORMANCE
STARTS IN YOUR HEAD
collection 2025- 21x 28 cm
AC 04 01 49 English
AC 04 01 49 IT Italiano
AC 04 01 49 FR Français
AC 04 01 49 DE Deutsch

style finder

EYEWEAR



AGENT Q
pg.62



ASTRAL
pg.52



ASTRAL X
pg.54



CUTLINE
pg.34



DEFENDER
pg.36



DELTABEAT
pg.58



GLAMSHADY | RX
pg.113



GLAMSHADY
pg.72



KELION
pg.32



IMPACT RX
collection
pg.88



INKAS
pg.96



INKAS FLIP-UP
pg.102



INKAS XL
pg.96



INKAS XL FLIP-UP
pg.104



IRIDIS 65
pg.110



IRIDIS 66
pg.111



LIGHTFLOW A
pg.66



LIGHTFLOW B
pg.67



LIGHTFLOW A | RX
pg.106



LIGHTFLOW B | RX
pg.107



MAGNUS
pg.40



NYAD
pg.42



OVERLAP
pg.69



PROPULSE
pg.60



PULSE 53
pg.108



PULSE 54
pg.109



RYDON
pg.46



RYDON SLIM
pg.48



RX DIRECT
collection
pg.86



RX DIRECT CLIP
collection
pg.94



RX OPTICAL DOCK
collection
pg.92



RX OPTICAL INSERT
collection
pg.90



RX READERS
collection
pg.98



SKYTRAIL
pg.74



SIRIUS
pg.56



SKERMO
pg.156



SOUNDRISE
pg.75



SPINAIR 57
pg.70



SPINHAWK EDGE
pg.73



SPINCUT
pg.154



SPINSHIELD
pg.50



SPINSHIELD AIR
pg.51



STARDASH
pg.44



STELLAR
pg.68



STELLAR | RX
pg.112



TURBOLENCE
pg.38

HELMETS



CROSSWAY
pg.144



EGOS
pg.134



NYTRON
pg.128



NYTRON PRO
pg.130



PROTERA+
pg.138



REBEL
pg.132



SKUDO
pg.146



SPECTRUM
pg.136



STRYM Z
pg.148



THE WING
pg.126



VENGER
pg.142



VENGER CROSS
pg.140



WINGDREAM
pg.124





RUDY PROJECT S.p.A Via B. Marcello, 44 - 31100 Treviso, Italy
Phone +39 0422 433 011 - Fax +39 0422 431 978 - info@rudypoint.com - www.rudypoint.com







FIND YOUR NEAREST RUDY PROJECT DISTRIBUTORS FOLLOWING THIS LINK:
WWW.RUDYPROJECT.COM/WW/EN/DISTRIBUTORS.HTML

Rudy Project pursues a policy of technological research and constant development of its products, so that the specifications and products illustrated in this catalogue are subject to change without notice. Rudy Project is not responsible for typographical mistakes or errors in printing colors. The best way to verify the color is to see the product at your Rudy Project retailer. All athletes and/or teams (names and/or pictures) shown in this catalogue are referred only and exclusively to the year 2023/2024.



helmets collection

													
	■ AERO/TRIATHLON		■ AERO/TRIATHLON		■ AERO/TRIATHLON ■ ROAD		■ AERO/TRIATHLON ■ ROAD		■ AERO/TRIATHLON ■ ROAD		■ AERO/TRIATHLON ■ ROAD		
SIZES	S-M	L	S-M	L	S-M	L	S-M	L	S-M	L	S	M	L
	55-58 cm 21,7-22,8"	59-61 cm 23,2-24"	55-58 cm 21,7-22,8"	59-61 cm 23,2-24"	55-58 cm 21,7-22,8"	59-61 cm 23,2-24"	55-58 cm 21,7-22,8"	59-61 cm 23,2-24"	55-58 cm 21,7-22,8"	59-61 cm 23,2-24"	51-55 cm 20,1-21,7"	55-59 cm 21,7-23,2"	59-63 cm 23,2-24,8"
WEIGHT	490 g 17,3 oz	460 g 16,2 oz	320 g 11,3 oz	360 g 12,7 oz	250 g 8,8 oz	300 g 10,6 oz	320 g 11,3 oz	360 g 12,7 oz	250 g 8,8 oz	280 g 9,9 oz	230 g 8,1 oz	250 g 8,8 oz	280 g 9,9 oz
IN MOLD TECHNOLOGY	■	■	■	■	■	■	■	■	■	■	■	■	■
WIND TUNNEL TESTED	■	■	■	■	■	■	■	■	■	■	■	■	■
FLOW THROUGH VENTILATION	1	2	15	3	22	25							
RETENTION SYSTEM	RSR 11 S	RSR 10 S M	RSR 10 M	RSR 10 M	RSR 11 S	RSR 11							
VERTICAL ADJUSTABILITY	■	■	■	■	■	■	■	■	■	■	■	■	■
CLOSURE CHIN BUCKLE	FIDLOCK buckle	FASTEX buckle	FASTEX buckle	FASTEX buckle	FASTEX buckle	FASTEX buckle	FASTEX buckle	FASTEX buckle	FASTEX buckle	FASTEX buckle	FIDLOCK buckle	FIDLOCK buckle	FIDLOCK buckle
DIVIDER SIDE BUCKLE	ERGO DIVIDER	DIVIDER PRO	DIVIDER PRO	DIVIDER PRO	DIVIDER PRO	ERGO DIVIDER	ERGO DIVIDER	ERGO DIVIDER	ERGO DIVIDER	ERGO DIVIDER	ERGO DIVIDER	ERGO DIVIDER	ERGO DIVIDER
BUG STOP PADDING									■	■			■
SNAP VISOR													
SAFETY REFLEX					■	■	■	■	■	■	■	■	■
MICROFIBER POUCH	■	■	■	■	■	■	■	■	■	■	■	■	■
AVAILABLE STANDARDS	CE/EN 1078 CPSC 12.03	CE/EN 1078 CPSC 12.03	CE/EN 1078 CPSC 12.03	CE/EN 1078 CPSC 12.03	CE/EN 1078 CPSC 12.03	CE/EN 1078 CPSC 12.03	CE/EN 1078 CPSC 12.03	CE/EN 1078 CPSC 12.03	CE/EN 1078 CPSC 12.03	CE/EN 1078 CPSC 12.03	CE/EN 1078 CPSC 12.03	CE/EN 1078 CPSC 12.03	CE/EN 1078 CPSC 12.03

																	
	■ AERO/TRIATHLON ■ ROAD ■ MTB ■ ALL ROAD			■ MTB ■ ALL ROAD		■ MTB ■ ALL ROAD			■ ROAD ■ ALL ROAD ■ URBAN			■ MTB ■ ALL ROAD		■ ROAD ■ MTB ■ ALL ROAD ■ URBAN		■ ROAD ■ MTB ■ ALL ROAD ■ URBAN	
SIZES	S	M	L	S-M	L	S	M	L	S	M	L	S-M	L	S-M	L	S-M	L
	51-55 cm 20,1-21,7"	55-59 cm 21,7-23,2"	59-63 cm 23,2-24,8"	55-58 cm 21,7-22,8"	59-61 cm 23,2-24"	51-55 cm 20,1-21,7"	55-59 cm 21,7-23,2"	59-63 cm 23,2-24,8"	51-55 cm 20,1-21,7"	55-59 cm 21,7-23,2"	59-63 cm 23,2-24,8"	55-58 cm 21,7-22,8"	59-61 cm 23,2-24"	55-58 cm 21,7-22,8"	59-61 cm 23,2-24"	55-58 cm 21,7-22,8"	59-61 cm 23,2-24"
WEIGHT	230 g 8,1 oz	260 g 9,2 oz	300 g 10,6 oz	360 g 12,7 oz	370 g 13 oz	240 g 8,5 oz	260 g 9,2 oz	280 g 9,9 oz	220 g 7,8 oz	240 g 8,5 oz	260 g 9,2 oz	250 g 8,8 oz	270 g 9,5 oz	250 g 8,8 oz	280 g 9,9 oz	250 g 8,8 oz	270 g 9,5 oz
IN MOLD TECHNOLOGY	■	■	■	■	■	■	■	■	■	■	■	■	■	■	■	■	■
WIND TUNNEL TESTED	■	■	■	■	■	■	■	■	■	■	■	■	■	■	■	■	■
FLOW THROUGH VENTILATION	15	18	22	22	23	17	16										
RETENTION SYSTEM	RSR 10 M	RSR 9	RSR 10	RSR 10	RSR 10 S	RSR 11 S	RSR 10										
VERTICAL ADJUSTABILITY	■	■	■	■	■	■	■	■	■	■	■	■	■	■	■	■	■
CLOSURE CHIN BUCKLE	FASTEX buckle	FASTEX buckle	FASTEX buckle	FASTEX buckle	FASTEX buckle	FASTEX buckle	FASTEX buckle	FASTEX buckle	FASTEX buckle	FASTEX buckle	FASTEX buckle	FASTEX buckle	FASTEX buckle	FASTEX buckle	FASTEX buckle	FASTEX buckle	FASTEX buckle
DIVIDER SIDE BUCKLE	DIVIDER PRO	DIVIDER PRO	DIVIDER PRO	DIVIDER PRO	DIVIDER PRO	ERGO DIVIDER	ERGO DIVIDER	ERGO DIVIDER	DIVIDER PRO	DIVIDER PRO	DIVIDER PRO	DIVIDER PRO	DIVIDER PRO	ERGO DIVIDER	ERGO DIVIDER	DIVIDER PRO	DIVIDER PRO
BUG STOP PADDING	■	■	■	■	■	■	■	■	■	■	■	■	■	■	■	■	■
SNAP VISOR																	
SAFETY REFLEX	■	■	■	■	■	■	■	■	■	■	■	■	■	■	■	■	■
MICROFIBER POUCH	■	■	■	■	■	■	■	■	■	■	■	■	■	■	■	■	■
AVAILABLE STANDARDS	CE/EN 1078 CPSC 12.03	CE/EN 1078 CPSC 12.03	CE/EN 1078 CPSC 12.03	CE/EN 1078 CPSC 12.03	CE/EN 1078 CPSC 12.03	CE/EN 1078 CPSC 12.03	CE/EN 1078 CPSC 12.03	CE/EN 1078 CPSC 12.03	CE/EN 1078 CPSC 12.03	CE/EN 1078 CPSC 12.03	CE/EN 1078 CPSC 12.03	CE/EN 1078 CPSC 12.03	CE/EN 1078 CPSC 12.03	CE/EN 1078 CPSC 12.03	CE/EN 1078 CPSC 12.03	CE/EN 1078 CPSC 12.03	CE/EN 1078 CPSC 12.03

ATTENTION

The Rudy Project helmets are engineered and manufactured with different specifications according to the markets of destination. If your helmet bears a CE designation, it meets the requirements of the Council Directive 89/686/ECC and of the European technical Standard EN 1078. If your helmet bears a CPSC designation, it meets the standard safety requirements of the U.S. Consumer Product Safety Commission. If your helmet bears a AS/NZS designation, it meets the standard safety requirements of the Australian Standard AS/NZS 2063.

CONCEPT AND LAYOUT RUDY PROJECT R&D DIVISION / 07.2024 | AC 04 01 49 | COPYRIGHT RUDY PROJECT®. ALL RIGHTS RESERVED. PRINTED IN ITALY.

